



Manual and Programmable Standards
Substituters and Test Instruments

Part 1

CALIBRATION • TEST • MEASUREMENT • METROLOGY



R-L-C • RTD • VOLTAGE • CURRENT

Contents	p. 2	Selection Guide.....	pp. 9-11
Application & Calibration Info.	pp. 4-8	Product Description	pp. 12-49
		Index	p. 89

Part 2

Standards and Instruments formerly manufactured by **GenRad**

STANDARDS • DECADES • STROBES • BRIDGES • AUDIO



1482 Standard Inductor	p. 51	1565-B Sound Level Meter	p. 70
1491 Decade Inductor	p. 53	1562-A Sound Level Calibrator	p. 71
1404 Standard Capacitor	p. 55	1531-AB and 1538-A Strobes	p. 72
1408 Standard Capacitor	p. 57	1539-A Stroboscopic Light Source	p. 74
1409 Standard Capacitor	p. 58	1542-B Strobotac® Stroboscope	p. 76
1412-BC Decade Capacitor	p. 60	1546 Strobotac® Digital Stroboscope	p. 78
1413 Precision Decade Capacitor.....	p. 62	1620-A Precision Cap. Meas. System	p. 80
1417 4-Terminal Capacitance Standard.....	p. 64	1621 High Precision Cap. Meas. System.....	p. 85
1422 Precision Variable Air Capacitor	p. 66	Other GenRad Products	Consult IET
1433 Precision Decade Resistor	p. 68		

Contents

Part 1

• CALIBRATION • TEST •
MEASUREMENT • METROLOGY
• R-L-C • RTD •
VOLTAGE • CURRENT

Contents 2
 Avoiding Measurement Problems..... 4
 Calibration Tutorial 5
 Glossary..... 8
Selection Guide..... 9
 RS • CS • LS • Series..... 12
 Decade Substituters
 Resistance • Capacitance • Inductance
 ohmSource Series 14
 Electronically Controlled Resistance
 Box
 HARS-X Series 15
 High Accuracy Decade Resistance Substituter
 HARS-L • HARS-LX • Series 17
 Laboratory Standard Decade
 Resistance Substituter
 HRRS Series 19
 High Resistance Decade Substituter
 HRRS-5kV Series 20
 High Resistance 5 kV Decade Substituter
 HPRS Series 22
 High Power Decade Resistance
 Substituter

PRS • PCS • PLS • PRTD • 23
 Programmable Impedance Decade Substi-
 tuter
 SRL • SRR • Series 27
 High Accuracy Standard Resistance
 SRX • SRA • SRC • Series 28
 Standard Resistance Reference or Working
 Standards
 VRS-100 Series 29
 High Resistance Standards
 RTD Simulator Series 30
 RTD Simulators
 SC Series 31
 Standard Capacitance Reference or
 Working Standards
 SL Series 32
 Standard Inductance Reference or Working
 Standards
 HATS-LR Series 33
 High Accuracy Transfer Standards -
 Low Resistance
 HATS-Y Series 34
 High Accuracy Transfer Standards -
 High Resistance
 KVD-500 • DP-500 • Series..... 35
 Digital Potentiometer and Kelvin-Varley
 Voltage Divider
 KVD-600 • KVD-700 • Series..... 36
 Kelvin-Varley Voltage Divider
 HACS Series 37

High Accuracy Capacitance Substituter
 2 or 3 Terminal Connections
 HACS-Z Series 38
 High Accuracy Capacitance Substituter
 SC-900 Series..... 40
 Precision Variable Capacitor
 VI-700 Series 41
 Precision Manual or Programmable
 Voltage and Current Source
 HSVR Series 42
 High Stability Standard Voltage Reference
 and Cell Replacement
 IMF-600A Series 43
 Digital Manual/Autoranging
 Impedance Meter
 LCR-500 45
 Autoranging Handheld High Performance
 Digital LCR Bridge
 LOM-510A Series 46
 High Accuracy Micro-Ohmmeter
 BP-511 48
 Battery Driven ac Power Source
 IEEE-488 and RS-232 Tools 24

Part 2

Standards and Instruments formerly
 manufactured by GenRad..... 50
 1482..... 51
 Standard Inductance
 Reference or Working Standards
 1491 53
 High Accuracy Decade Inductor
 1404..... 55
 Standards Laboratory grade
 Capacitance
 1408..... 57
 Standard Capacitance with oven
 1409..... 58
 Standard Capacitance Reference or
 Working Standards
 1412..... 60
 Polystyrene Decade Capacitor

1413..... 62
 Precision Decade Capacitor
 1417 64
 Four-Terminal Capacitance Standard
 up to 1 F
 1422..... 66
 Low-loss Variable Air Capacitors
 1433..... 68
 Precision Decade Resistors
 1565-B..... 70
 Sound-Level Meter
 1562-A 71
 Sound-Level Calibrator
 1531-AB and 1538-A 72
 Electronic Stroboscopes
 1539-A 74
 Stroboscopic Light Source

1542-B..... 76
 Strobotac® Stroboscope
 1546..... 78
 Strobotac® DigitalStroboscope
 1620-A 80
 Precision Capacitance Measurement System
 1621 85
 High Precision Capacitance
 Measurement System
 Warranty 88
 Ordering Information..... 88



Support

If you cannot find what you need, we stand ready to help find or design your solution. That is our business.

Please call or visit
www.ietlabs.com

To order or for before and after sales technical assistance:

Telephone: (516) 334-5959
(800) 899-8438
FAX: (516) 334-5988
Web site: www.ietlabs.com



Technical Applications

The following are some common conditions that may cause errors in measurement and metrology and some techniques to avoid or minimize them.

Condition	Effect	Suggestions
Power applied to Device Under Test (DUT)	Self heating in resistive components causes a temperature effect and a corresponding resistance change.	<ul style="list-style-type: none"> - Use low test signals or pulsed measurement. - Heat sink the DUT. - Allow for effects of power coefficient of resistance. - Use low power coefficient components.
High voltage applied to DUT	Some high resistance resistors have a significant voltage coefficient of resistance.	<ul style="list-style-type: none"> - Use low voltage coefficient components. - Measure at low voltages. - Allow for the effects of the voltage coefficient of resistance.
Ambient temperature	Temperature coefficient effects; possible permanent retrace effects may result from large shipping or storage temperature shifts.	<ul style="list-style-type: none"> - Maintain stable temperature and minimize exposure to temperature extremes.
Humidity	Humidity may cause leakage effects on high resistance components.	<ul style="list-style-type: none"> - Maintain relative humidity under 50%.
Thermal emf	The thermal emf, i.e. the voltage generated at contacts of dissimilar metals at temperature gradients, can cause erroneous voltage and resistance measurements.	<ul style="list-style-type: none"> - Use Cu to Cu contacts and leads wherever possible; silver contacts and solder are acceptable. - Avoid using steel and brass. - Minimize temperature gradients or drafts. - Use switched or "true ohm" measurement instruments. - Alternate leads to determine the degree of the problem.
Low resistance	Lead resistance and thermal emf may introduce errors.	<ul style="list-style-type: none"> - Use 4-wire measurement, Kelvin leads. - See thermal emf (above).
High resistance	Leakage through lead insulation and bench-top, resulting from humidity, may cause errors.	<ul style="list-style-type: none"> - Use low leakage insulation such as Teflon™ - Set DUT on high insulation subplate. - Maintain all terminals clean. - Shield and avoid high voltage and movement nearby. - Use 5 or 6 terminal guard circuit.
Ground loops	Ground currents can introduce noise and offset voltage.	<ul style="list-style-type: none"> - Use radial grounds to only one reference point.
Test conditions	Most resistors, capacitors, and inductors are non-ideal; wirewound resistors are both inductive and capacitive; capacitors have losses, and inductors can be very resistive. Test conditions of voltage, frequency and model (parallel or series) may be significant to the measurement.	<ul style="list-style-type: none"> - Apply the instrument test conditions that are the most representative model of the DUT.

See pages 7 and 8 for Selection Guide



Calibration Definitions and Terminology

Accuracy: The conformity of a measurement to an accepted standard value. Thus, 3.14159 is a more accurate statement of π than is 3.14160. Accuracy includes traceability to Si, a recognized national or international standards organization. It also includes all other uncertainties and nonlinearities.

The accuracy of a measurement X_i is an interval $[a_-, a_+]$ such that the probability that the True Value of X_i (either nominal or specified) lies within the interval $[a_-, a_+]$ is, for all practical purposes 100%; and the probability that it lies outside that interval is essentially zero.

True Value of a quantity is the value consistent with the definition of a given particular quantity. This is the value that would be obtained by a perfect measurement.

Calibration Accuracy or Calibration Uncertainty or Uncertainty of Measurement: The sum of the uncertainties in the calibration procedure, including the uncertainties in the references, test instruments, transfers, etc.

The uncertainty of measurement is the parameter, associated with the result of a measurement, that characterizes the dispersion that could reasonably be attributed to the measurand. This is viewed as a doubt about the validity of a measurement, i.e. a measure of the possible error in the estimated value of the measurand as provided by the result of a measurement.

Calibration accuracy must be better than the specified accuracy or initial accuracy and will either be stated or will be less than 25% of the specified accuracy of the measurement.

Initial Accuracy: Accuracy at the time of shipment.

All Accuracy references in this catalog shall operationally be understood as the Initial Accuracy.

Adjustment to Nominal: The maximum allowable difference between the actual value supplied with the standard and the nominal value, e.g. how far may a 1 H inductor be sup-

plied with a stated and calibrated value away from the nominal 1 H. This quantity is unrelated to accuracy and uncertainty statements.

Stability or Long-Term Accuracy: The measurement that will predict the worst case error for the period indicated, typically a year. To determine the worst case error after one year, the initial accuracy is added to the one year stability.

Transfer Accuracy: A comparison of two nearly equal measurements over a limited time and temperature. IET's HATS-LR and HATS-Y transfer standards may be used as described below to transfer accuracies over three decades.

[See p. 6 for a tutorial on the use of transfer standards.](#)

Short-Term Accuracy: The limit that errors will not exceed during a 24-hour period of continuous operation. Unless specified, no zeroing or adjustments of any kind are permitted. The transfer accuracy obtained with IET's transfer standards is a short term accuracy.

Test Conditions: These comprise the assumptions and facts describing the environment, instrument and sample to be measured. These will include temperature, relative humidity, power, frequency, etc. If a standard is used in other conditions, e.g. at a different voltage or temperature or power, then the temperature coefficient or power coefficient or voltage coefficient or other variation may be used to predict the value of the quality under the nonstandard conditions.

Resolution: The digital value represented by one bit in a display in a digital measure. For example, if one bit represents 1 m Ω , then resolution is 1 m Ω .

Precision: The degree of exactness with which a measurement or quantity is stated - e.g., 3.14159 is a more precise value of π than 3.14.

Repeatability: The closeness of agreement among a number of consecutive measurements performed under the same operating conditions. Long-term and short-term repeatability are both important.



Technical Applications

p. 2 of 3

Calibration Definitions Application Example:

See the IET SRL Series (p. 27), for an example of how the above definitions apply. Note the chart below.

- A 1 Ω SRL standard is specified with an Adjustment Range or Adjustment to Nominal of ±2 ppm, i.e. the device true value can be 1 Ω ±2 ppm
- A particular unit may be supplied with a value of 1 Ω + 0.8 ppm. This value would be given with the unit.
- This standard would be accurate to 1.000 000 8 Ω ±1 ppm, 1 ppm being the Calibration Accuracy or Calibration Uncertainty.
- For predicting the value with time, the Stability, typically ±2 ppm, would be added for one year.



SRL-1 High Accuracy Resistance Standard
Requiring No Temperature Bath

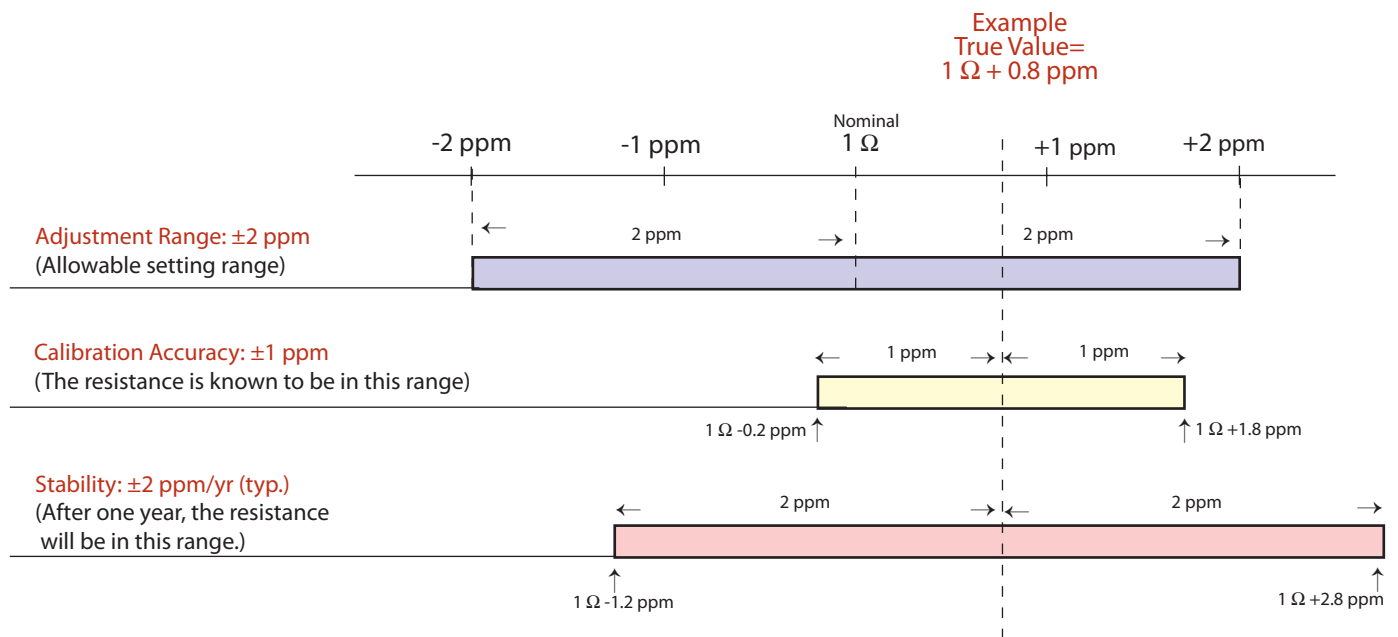

Using Transfer Standards

Benefits of Using Transfer Standards

In order to perform calibrations with a high degree of accuracy, reference standards must be employed at every range or decade of the measuring or calibration instrumentation.

Clearly, this can be difficult and costly since these standards must be highly stable and their precise values must be known with a high degree of certainty and with a sufficient resolution. To minimize the cost and difficulty, more practical means of performing such calibrations is to use transfer standards.

If one has a single standard that is calibrated by a national laboratory, one can then transfer the "certified" accuracy by comparing the "certified" standard to the transfer standard for as many as three decades.

The resulting accuracy of the transfer process can be much better (e.g. 1 ppm) than the accuracy of the transfer standard itself (e.g. 15 ppm). This may be understood as follows: a stable, but only moderately accurate, ruler could be used to accurately transfer measurement from one object of accurately known length to a second object of unknown length. This transfer is virtually limited only by the accuracy of the known length.

The IET HATS-LR Series of transfer standards (p. 33) consist of 12 matched equal value resistors of value R, designated as R1 through R12, which may be connected in series or parallel combinations to produce any number of values such as R/10, R and 10R. This permits the progressive transfers to higher or lower decades. For resistances above 1 MΩ, the HATS-Y Series of transfer standards (p. 34) may be used, and the same discussion applies.

Setting for Various Resistance Combinations

To obtain a resistance R of one step, any single resistor may be used, but it is clearly advantageous to use as many of them together as possible in combination. This not only allows the applied power to be divided among the set, but permits the use of a number of resistors in determining the net statistical resistance, always better for a larger number. In particular, 9 resistors are connected in a series-parallel combination. The best method to implement this circuit is to use the Model HATS-LR-SB set of shorting bars (p. 33).

Similarly, the value of R/10 may be implemented by a parallel combination of 10 resistors. This again may be conveniently done with the shorting bars. This takes statistical advantage of 10 resistors in combination. Of course, using 10 resistors in a series combination will produce 10R with the same statistical

and power advantage.

It is important to note that any series, parallel, or series-parallel configuration results in the net deviation being equal to the average deviation for that group of resistors no matter how they are connected, as long as the applied power is divided equally among the resistors. This is clearly the case with the R/10 and the 10R configurations, i.e. they have the same deviations. It is also true with the 9 resistor series-parallel configuration, since the effect of deviation of a single missing resistor may be safely neglected. This property is very useful since it permits making accurate transfers across three decades with one single unit.

Calibration Transfers



Parallel Combination

As an example, a 10 kΩ standard may be compared with a HATS-LR unit with 10 kΩ steps connected in a series-parallel configuration, as described above, to provide a net 10 kΩ resistance. Once a comparison is made, a net deviation of 10 resistors (approximately the same as for 9 resistors) is obtained.

This average or net deviation remains constant for a series combination, and therefore the standard is effectively "transferred" with the same deviation plus the transfer accuracy of the unit to another decade, 10R or 100 kΩ in this example.

This deviation is also transferrable to 1 kΩ by using the HATS-LR in the parallel mode.

This process may be continued with another transfer standard. 1 MΩ steps in this example could first be configured in the R/10 mode to produce 100 kΩ, which would be compared to the first standard set in the 10R mode. This now produces the additional values of 1 MΩ and 10 MΩ with known deviations close to the original standard. Only the transfer accuracy errors have to be added for each transfer.

Referring to the same example, a transfer may of course also be extended downwards. A standard with 100 Ω steps would be set in a series for 1 kΩ and compared with the original standard and would subsequently provide a transfer at 100 Ω and 10 Ω.

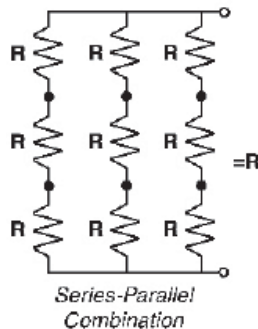

Series-Parallel Combination

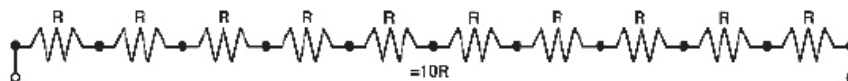

Series Combination



Technical Applications

Glossary and Useful Definitions

Autoringing: The ability of an instrument to switch among ranges automatically. The ranges are usually in decade steps.

Bias Voltage: A voltage applied to a device to establish a reference level for the operation of the device during testing.

Capacitance: In a capacitor or system of conductors and dielectrics, the property that permits the storage of electrically separated charges when potential differences exist between the conductors. Capacitance is related to charge and voltage as follows: $C = Q/V$, where C is the capacitance in farads, Q is the charge in coulombs, and V is the voltage in volts.

Cold Switching (or Dry Switching): Closing relay or switch contacts before applying voltage and current and removing voltage and current before opening the contacts. (Contacts do not make or break current.)

Compliance Voltage: The maximum output voltage of a constant current source.

Conductance (G): The reciprocal ($1/R$) of resistance, usually specified in Siemens (S).

Four-Terminal Resistance Measurement: See Kelvin terminals.

GPIB (General-Purpose Interface Bus): See IEEE-488

IEEE: Institute of Electrical and Electronics Engineers.

IEEE-488: A standard for remote control of test equipment.

Kelvin Terminals (Four-Terminal Resistance Measurement): A means for testing or making measurements in electronic devices and circuits, particularly when small impedances are being measured. Two sets of leads are used at each test point, similar with respect to thickness,

material and length; one set carries the test signal and the other connects with the measuring instrument. The effect of resistance in the leads is thus eliminated.

Power Coefficient of Resistance: A change in resistance with a change in applied power, expressed as a percentage or ppm of readings per watt.

Parts per Million (ppm) : A measure of small ratios, usually applied to calibrations or accuracies; $1 \text{ ppm} = 10^{-6}$ or .0001%, and $1\% = 10,000 \text{ ppm}$.

Root Mean Square (rms): The square root of the average value of a waveform, indicative of power.

Root Sum Square (RSS): The square root of the sum of various components, typically used to combine the components contributing to uncertainty.

RTD, Resistance Temperature Detector: A sensor which will detect temperature by a varying resistance. IET offers manual or programmable RTD simulators.

Temperature Coefficient: A change in a quantity, such as resistance, with a change in temperature, expressed as a percentage or ppm of reading per degree change in temperature.

Thermal emf: Voltages resulting from temperature differences within a measuring circuit or when conductors of dissimilar metals are joined together. See p. 3 for more details.

Two-Terminal Resistance Measurement: A measurement where the same current flows through the unknown and the test leads. See Kelvin Terminals.

Voltage Coefficient of Resistance: A change in resistance with a change in applied voltage, expressed as a percentage or ppm of resistance per volt. This generally applies to very high resistance values only, over $10 \text{ G}\Omega$.

Zero Offset: The reading (desired or undesired) that occurs when the input terminals of a measuring instrument are shorted.



DECADE SUBSTITUTERS • DIVIDERS

RESISTANCE

Series	Type	Basic Accuracy	Range	Max. Resolution	Features	Page
RS	General purpose	0.1% (or better) to 1%	1 - 1000 M Ω	10 m Ω	General purpose; economical; thumbwheel switches	12
NEW! OhmSource	Elec-Res Box	0.1%	0.5 Ω - 24 M Ω	10 m Ω	Economical, microprocessor controlled	14
HARS-X	High accuracy	0.01%	0-111 M Ω	1 m Ω	Laboratory grade; high accuracy; high stability; low zero resistance; low temperature coefficient; suitable for RTD simulation.	15
HARS-Q	High accuracy	0.02%	0-111 M Ω	1 m Ω		15
HARS-A	High accuracy	0.05%	0-111 M Ω	1 m Ω		15
HARS-B	High accuracy	0.1%	0-111 M Ω	1 m Ω		17
HARS-L	Lab/cal grade	25 ppm + 0.5 m Ω absolute	10 m Ω - 120 M Ω	1 m Ω , 20 $\mu\Omega$		
HARS-LX	Lab/cal grade	20 ppm + 0.5 m Ω absolute	10 m Ω - 120 M Ω	1 m Ω , 20 $\mu\Omega$		
NEW! GenRad 1433	High accuracy	0.01%	0-111 M Ω	1 m Ω	Laboratory grade	68
HRRS	High resistance	0.01% - 1%	0 - 11 T Ω +	10 Ω	High resistance.	19
NEW! HRRS-5kV	High resistance High voltage	0.01% - 1%	0 - 11 T Ω +	10 Ω	High resistance to 5 kv.	20
HPRS	High power	0.5% - 1%	0 - 10 M Ω	1 m Ω	High power; 25 W/step; 250 W max.	22
PRS	Programmable	0.01% - 1%	0 - 100 M Ω	1 m Ω	IEEE-488 or RS-232 BCD	23
HATS-LR	Transfer standard	1 ppm transfer	1 Ω - 100 k Ω /step	1 Ω	High accuracy transfer standard	33
HATS-Y		2 ppm transfer	100 k Ω - 10 M Ω /step	100 k Ω		34
KVD-700	Kelvin-Varley voltage divider	0.1 ppm linearity	0 - 1100 V	0.1 ppm	Highly accurate for bridge applications to measure and calibrate voltages, resistance, etc.	36
KVD-600		0.5 ppm linearity				
KVD-500		0.05% - 1%				
DP-500	True digital pot	0.05% - 1%	0 - 50 M Ω	1 ppm	Suitable as component	35

CAPACITANCE

Series	Type	Basic Accuracy	Range	Max Resolution	Features	Page
CS	General purpose Decade	0.5% - 4%	0 - 1000 μ F	1 pF	General purpose; economical; thumbwheel switches.	12
HACS	High accuracy Decade	0.05% - 0.1%	100 pF - 1111 μ F	100 pF	Laboratory grade; high accuracy; high stability; low temperature coefficient.	37
HACS-Z	High accuracy; low zero capacitance Decade	0.05% - 0.1%	0 - 10,000 μ F	1 pF		38
GenRad 1412	Stable polystyrene	0.5%	50 pF	1 pF	Precision decade with variable fine adjustment	60
GenRad 1413	High Accuracy low zero	0.05%	0 - 1.111 11 pF	1 pF	Laboratory grade; high accuracy; high stability; low temperature coefficient.	62
GenRad 1417	High Capacitance Standard	0.02%	1 μ F - 1 F	1 μ F	High value precision capacitance	64
PCS	Programmable Decade	0.5% - 4%	0 - 1000 μ F	1 pF	IEEE-488 or BCD programmable	23
GenRad 1422	Precision variable air capacitor	0.1 pF - 1.5 pF	10 - 1100 pF	0.02 pF	High resolution and stability; low loss.	66

INDUCTANCE

Series	Type	Basic Accuracy	Range	Max Resolution	Features	Page
LS	General purpose Decade	1% (or better) - 4%	1 - 100 H	1 μ H	General purpose; economical; thumbwheel switches.	12
PLS	Programmable Decade	2% (or better) - 4%	1 - 100 H	1 μ H	IEEE-488 or BCD programmable.	24
GenRad 1491	High Accuracy Decade	0.8%	100 μ H - 11 H	100 μ H	Laboratory grade; high accuracy; high stability; low temperature coefficient.	53



DECADE SUBSTITUTERS • DIVIDERS

VOLTAGE AND CURRENT

Series	Type	Basic Accuracy	Range	Max Resolution	Features	Page
VI-700	Precision V-I	75 ppm	100 μ V - 200 V	100 μ V - 200 V	General purpose; programmable	41.

RTD SIMULATORS

Series	Type	Basic Accuracy	Range	Max Resolution	Features	Page
RTD-250	Manual, economy	200 ppm	10 Ω - 11 k Ω	10 m Ω	General purpose, economy	30
RTD	Manual, precision	50	10 Ω - 11 k Ω	1 m Ω	General purpose; high accuracy; absolute settings; no zero subtraction required.	30
PRTD	Programmable	0.01% - 0.1%	4 Ω - 10 M Ω	1 m Ω	IEEE-488 or BCD programmable; absolute settings; no zero subtraction required.	23

STANDARDS • RESISTANCE

Series	Type	Calibration Accuracy	Range	Features	Page
SRL	Resistance, lab/cal grade	as low as 1 ppm	1 m Ω - 10 T Ω	Extremely high precision and stability; very low temperature coefficient.	27
SRX	Resistance, high accuracy	as low as 2 ppm	1 m Ω - 100 M Ω	Accurate, portable, economical.	28
SRA	Resistance, economy	as low as 2 ppm	1 m Ω - 100 M Ω	Accurate, portable, economical.	28
SRC	Resistance, high resistance	as low as 15 ppm	19 M Ω - 10 T Ω	Accurate, portable, economical	28
VRS-100	Resistance, high resistance	2 - 2500 ppm	1 k Ω - 10 T Ω	Discrete steps	29
HATS	Transfer standard	1 ppm	1 Ω - 10 M Ω /step	High accuracy transfer standard	33, 34

STANDARDS • CAPACITANCE

Series	Type	Calibration Accuracy	Range	Features	Page
GenRad 1404	Capacitance, Nat'l std lab type	5 - 11 ppm	10 - 1000 pF	Very accurate and stable; very low TC	55
GenRad 1408	Capacitance w/oven	5 - 11 ppm	10 - 1000 pF	Dual unit with virtually zero TC	57
SCA	Capacitance, high accuracy	0.01% - 0.04%	1 pF - 1000 μ F	Accurate, portable, economical.	31
GenRad 1409	Capacitance, high accuracy	0.01%	10 pF - 1000 μ F	Accurate, stable, economical	58

STANDARDS • INDUCTANCE

Series	Type	Calibration Accuracy	Range	Features	Page
SLC	Inductance	0.8%	100 μ H - 10 H	Toroidal inductors, economy.	32
GenRad 1482	Inductance	0.025%	100 μ H - 10 H	National Standard Laboratory grade.	51



STANDARDS • VOLTAGE • CURRENT

Series	Type	Calibration Accuracy	Range	Features	Page
HSVR	Voltage lab/cal grade	1-2 ppm	1.01 V - 18.9 V	Low temperature coefficient, small size.	42
VI-700	Precision voltage & current source	75 ppm	100 μ V - 200 V	General purpose; programmable.	41

TEST INSTRUMENTS

Series	Type	Features	Page
GenRad 1620	High Precision Capacitance Measurement System	10 ⁸ pF to 11.1 pF, 0.01% accuracy; 1 ppm resolution	79
GenRad 1621	Ultra Precision Capacitance Measurement System	10 ⁻⁷ pF to 10 μ F - 12 digit resolution	87
IMF-600A	Impedance and multifunction meter	Multipurpose; digital output, current output, analog output, autoranging.	43
LCR-500	Impedance - LCR meter	Autoranging; portable; multiple features.	45
LOM-510A	High accuracy micro-ohmmeter	1 $\mu\Omega$ resolution; high accuracy; portable.	46
BP-511	Universal battery pack and ac power source	Can power and make portable almost any instrument.	48

WINDOWS AND IEEE-488 TOOLS

Series	Description	Features	Page
LabView	Software tool for designing and developing test, measurement, and data acquisition applications for Windows	Drag and drop interface; powerful data acquisition, I/O, math, display functions, and many other extensive features.	23-26
NI	IEEE-488 Interface software and hardware	Fast data transfer; IEEE-488.2 compatible. Supports Windows 95 and NT; compatible with Industry's most popular software packages.	23-26

AUDIO • SOUND - Formerly manufactured by GenRad

Series	Type	Features	Page
GenRad 1565	Sound Level Meter	4-140 dB; ANSI type 2; A, B, C weighting.	70
GenRad 1562	Sound Level Calibrator	Calibrates most sound level meters.	71

STROBES - Formerly manufactured by GenRad

Series	Type	Features	Page
GenRad 153X	Stroboscopes, high speed, portable	Flash rates up to 25,000 fpm	72
GenRad 1539	Stroboslave light source	Externally triggered flash rates up to 25,000 fpm	74
GenRad 1542	Strobotac, compact, economy	Up to 3,800 bright white fpm	76
GenRad 1546	Strobotac digital Stroboscope	Quartz accuracy 0.01%	78



RS • CS • LS • Series

p. 1 of 2

Economical, indispensable tools for a variety of uses in engineering, design, troubleshooting, or service.

Best Substituter Value Available

- Direct reading — No fumbling with multiple slide or rotary switches
The IET family of digital substituters uses convenient side by side thumbwheel switches. Simply dial in the desired values and use.
- Accurate
In addition to standard 1% economical units, tolerances of 0.1%, 0.05%, 0.01%, and others are available.
- Broad choice of standard and optional models with many powerful features
A full line of standard substituters will satisfy most requirements. Other IET families of precision products include:
 - Laboratory standards
 - Transfer standards
 - Programmable control
 - RTD simulation
 - High power
 - Very high resistance
- Error proof
Since the impedance values are set and read directly, no mistakes can be made as with rotary or slide switch decade boxes. No need to examine and sum groups of switches — simply read one number.
- Color coded
Different colored switches separate the various impedance ranges.
- Compact, convenient, and rugged
Made of high impact plastic, these substituters are very portable and reduce clutter on a busy lab bench.

OPTIONS

- Shielded case with grounding post
- Panel mounting
- Low residual impedance switch
- Protection fuse
- Programmable control (See p. 23)

The RC-box, shown on the right, combines the features and specifications of both the R-box and the C-box in one convenient package. Ideal for setting timers, oscillators, and filters, the resistance and capacitance may be used independently, in series, or in parallel. A shorting link allows them to be coupled or separated.

R-box

RS Series
Digital
Resistance
Substituter



Available from 0.01 Ω to 299,999,999.9 Ω
(RS-201 shown)

C-box

CS Series
Digital
Capacitance
Substituter



Available from 1 pF to 999.9999 μF
(CS-300 shown)

L-box

LS Series
Digital
Inductance
Substituter



Available from 1 μH to 99.99999 H
(LS-400 shown)

RC-box
RCS Series
Digital Resistance-
Capacitance
Substituter



Combination Resistance-Capacitance
(RCS-500 shown)



RS • CS • LS • Series

p. 2 of 2

SPECIFICATIONS - STANDARD MODELS

Model	RS-200	RS-201	RS-200W	RS-201W	CS-300	CS-301	RCS-500	RCS-502	LS-400	LS-400A
Type of Substituter	Resistance	Precision Resistance	Wide Range Resistance	Wide Range Precision Resistance	Capacitance	Precision Capacitance	Resistance-Capacitance	Precision Resistance-Capacitance	Wide-Range Inductance	Inductance
Accuracy*	±(1%+25 mΩ)	±(0.1%+25 mΩ)	±(1%+30 mΩ)	±(0.1%+30 mΩ)*	±(4%+3 pF)	±(1%+3 pF)	Combines RS-200 and CS-300	Combines RS-201 and CS-301	±(2%+0.5 μH)	±(2%+0.5 μH)
Decades	7		9		6				4	3
Range	0 - 9,999,999 Ω		0-99,999,999.9 Ω		0 - 99.9999 μF				0 - 9.999 H	0 - 999 mH
Resolution	1 Ω		0.1 Ω		100 pF		1 mH	1 mH		
Type of Components	Metal film resistors; wirewound or resistance wire for 0.9 Ω and under				100 - 900 pF: mica 0.001 - 0.009 μF: polystyrene 0.01 - 0.9 μF: polycarbonate 1 - 9 μF: polyester 10 - 90 μF: polarized tantalum		Toroidal Inductors			
Ratings	0.5 W**				100 V (20 V for 10 - 100 μF)		See table below			
Residual Impedance	≤0.39 Ω (≤0.056 Ω/decade)		≤0.5 Ω (≤0.056 Ω/decade)		≤42 pF (≤7 pF/decade)		≤0.23 Ω (≤0.056 Ω/decade)			
Physical	8.1 x 7.9 x 5.6 cm; 184 g (3.2 x 3.1 x 2.2 in; 6.5 oz.)		12 x 7.9 x 5.6 cm; 235 g (4.7 x 3.1 x 2.2 in; 8.3 oz)		12 x 7.9 x 5.6 cm; 235 g (4.7 x 3.1 x 2.2 in; 8.3 oz)		18.8 x 11 x 6 cm, 410 g (7.4 x 4.3 x 2.4 in, 14 oz)		12 x 7.9 x 5.6 cm, 230 g (4.7 x 3.1 x 2.2 in, 8 oz)	

* Accuracy after subtraction of the Residual Impedance; traceable to SI.
RS-201W: 0.2% for ≥10 MΩ.
CS-Series Test Conditions: 1 kHz; 1 Vrms; 120 Hz for ≥10 μF, series model; 23°C.
LS-Series Test Conditions: 1 kHz; 1 Vrms; series model; 23°C.
** Higher power resistance substituters (1 W or higher) available; see optional models below or HPRS data sheet.

Additional information for Inductance Substituters

Inductance	Frequency Range	Max. Q	Rating
0.1 - 0.9 mH	300 Hz - 2 MHz	100 @ 800 kHz	700 mA
1 - 9 mH	300 Hz - 1 MHz	80 @ 40 kHz	500 mA
10 - 90 mH	300 Hz - 800 kHz	80 @ 40 kHz	300 mA
0.1 - 0.9 H	300 Hz - 200 kHz	40 @ 20 kHz	100 mA
1 - 9 H	200 Hz - 20 kHz	30 @ 8 kHz	20 mA
10 - 90 H	200 Hz - 6 kHz	60 @ 2 kHz	4 mA

OPTIONAL MODELS

In order to satisfy any requirements for decade substituters, construct a part number from the table below, or consult IET Labs.

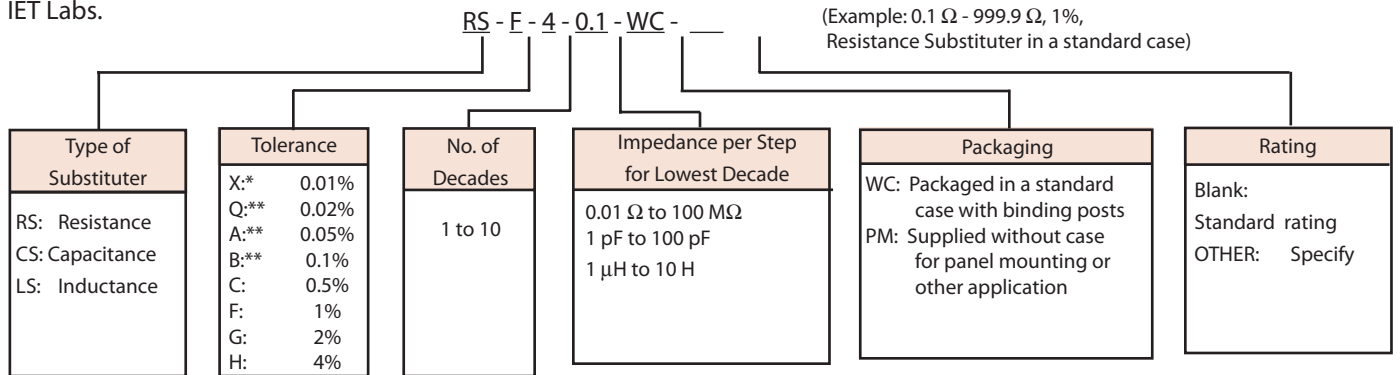

* See HARS and HACS Series for standards grade resistance and capacitance substituters; **for Q, A, and B tolerances, 0.2% for ≥10 MΩ.

OPTIONS

- CC-25 Dual Lead Clip - plugs into dual binding posts for convenient lead connections
 - LR Residual Impedance is reduced to 0.06 Ω or 7 pF on lowest decade by isolating it from the remaining decades
 - SC Shielded case with grounding terminal
 - PM Panel mounting version
 - FP Unit supplied with series 2 A fuse for added protection (User may substitute other fuses; residual impedance will increase by 0.06 Ω for 2 A fuses)
 - LP Unit supplied with low profile binding post
- OTHER VERSIONS**
- Programmable Version See PRS/PCS/PLS data sheet (p. 17)
 - High Power Version See HPRS data sheet (p. 16)
 - High Accuracy Version See HARS data sheets (p. 11)
 - High Resistance Version See HRRS data sheet (p. 15)



ohm Source Series

Electronically Controlled Resistance Box Your SOURCE of Resistance!

The ohmSOURCE Resistance Box product line is like nothing you have ever seen before! Microprocessor-controlled and loaded with innovative features, the ohmSOURCE Resistance Box succeeds in providing highly accurate and precise resistance values in an intuitive and user-friendly fashion. With a resistance value range of up to 24 MΩ and a power rating of up to 1 Watt, the handheld ohmSOURCE is practical for all industries including automotive, medical, test & measurement, telecommunications, and HVAC.

Automatic RTD simulation

The Translation Table Add-on enables the user to download and store data tables in the ohmSOURCE Resistance Decade Box for translating a known, user-definable physical characteristic into a resistance value. Use this option to simulate

any type of transducer that converts a physical phenomenon into a resistance value: thermistors, conductivity sensors, etc... Each table may contain up to 256 equivalences.

Using the RS-232 interface and the Software Development Kit, you can control the ohmSOURCE from a remote computer and design automated test equipment to fit your custom application.

Uses real resistors.



RTD values may be stored and recalled by temperature setting

FEATURES AND BENEFITS

- **Keypad Interface**
Enter resistance values using a calculator-style keypad.
- **Quick Value Keys**
Recall up to four frequently used resistance values with one touch.
- **Memory Keys**
Store resistance values in up to 10 additional memory locations (0-9).
- **Current Limiter (user-defined)**
Limits the amount of current passing through the ohmSOURCE to prevent possible damage.
- **Increment Value Setting**
Change resistance by user-defined increments or select standard resistance values (1%, 5%, 10%)
- **Open Key**
Conveniently 100% mechanically isolate the ohmSOURCE from the application with the touch of a key.
- **Easy-to-Read Display**
The output resistance value, in ohms, is easily read from the large, graphical LCD display.
- **Automatic Residual Resistance**
The residual resistance of the ohmSOURCE is automatically included in the output resistance value.
No zero subtraction is required.
- **Auto-Off Power**
The ohmSOURCE automatically shuts off after 4 minutes of inactivity to conserve power.
- **Field Calibration**
Easily calibrate the ohmSOURCE with a high precision ohmmeter. Annual factory calibration recommended.
- **FLASH Software Updates**
The microprocessor has FLASH program memory to allow reprogramming of product firmware.
- **Accessories**
 - OS-91.001 Software Development Kit
 - Software & Hardware Tools for Advanced Customization
 - OS-91.002 Test Leads
 - Dual Banana Plug to Mini-Alligator Clips

SPECIFICATIONS

	Model OS-250	Model OS-260	Model OS-270
Range	Rmin* to 24,000,000 Ω	Rmin* to 24,000,000.0 Ω	Rmin* to 1,500,000.00 Ω
Resolution	1 Ω	0.1 Ω	.01 Ω
Accuracy no zero subtraction	±1 Ω, for 1 kΩ and under ±0.1%, for over 1 kΩ	±0.5 Ω, for 1 kΩ and under ±0.1%, for over 1 kΩ	±0.1 Ω, for 5 kΩ and under ±0.01%, for over 5 kΩ
Power Rating	1.0 W	1.0 W	1.0 W
Power Supply	4 AA alkaline batteries	4 AA alkaline batteries	4 AA alkaline batteries

Rmin*: Minimum settable resistance, determined at calibration, approximately 1 Ω.



HARS-X Series

p. 1 of 2

Tight tolerance laboratory grade decade substituters, for applications requiring a cost effective high performance resistance decade box.

- Resistance from 1 mΩ to 111 MΩ
- Excellent stability - 10 ppm/yr, 25 ppm/ 3 yrs
- Wide choice - single through 11 decade units
- High accuracy - 0.01% (100 ppm)
- Very low zero resistance: <1 mΩ per decade
- High performance solid silver alloy switches
- Low temperature coefficient - 5 ppm/°C
- Noninductive or low inductance resistors

- Rack mounting available
- Special and custom configurations available



6 Decade HARS-X High Accuracy Resistance Substituter

- See HRRS Series for higher resistance
- See HPRS Series for higher power
- See HARS-L Series for higher accuracy
- See RTD Series for RTD simulators
- See PRS Series for programmable models

SPECIFICATIONS

Resistance per Step	Total Decade Resistance	Stability (±ppm/year)	Long Term Stability (±ppm/3 years)	Temperature Coefficient (±ppm/°C)	Max. Power (W/step)	Maximum current (per decade)	Maximum voltage (per step)
1 mΩ	10 mΩ	100	700	50	0.04	8 A	5 mV
10 mΩ	100 mΩ	50	350	20	0.2	4 A	40 mV
100 mΩ	1 Ω	30	50	20	0.25	1.6 A	0.16 V
1 Ω	10 Ω	10	25	20	0.6	0.8 A	0.8 V
10 Ω	100 Ω	10	25	15	0.6	0.25 A	2.5 V
100 Ω	1 kΩ	10	25	5	0.6	80 mA	8 V
1 kΩ	10 kΩ	10	25	5	0.5	23 mA	23 V
10 kΩ	100 kΩ	10	25	5	0.5	7 mA	70 V
100 kΩ	1 MΩ	10	25	5	0.5*	2.3* mA	230 V*
1 MΩ	10 MΩ	10	25	10	0.5*	0.7* mA	700 V*
10 MΩ	100 MΩ	50	40	10	0.1*	0.1* mA	1000 V*

* Subject to maximum of 2000 V to case.

Accuracy: After subtraction of zero resistance, at 23°C; traceable to SI.

- HARS-L: ± 20 ppm (see p 17)
- HARS-Z: ±(50 ppm + 1 mΩ)
- HARS-X: ±(0.01% + 2 mΩ); ±0.03% for 10 MΩ steps.
- HARS-Q: ±(0.02% + 2 mΩ); ±0.05% for 10 MΩ steps.
- HARS-A: ±(0.05% + 2 mΩ); ±0.1% for 10 MΩ steps.
- HARS-B: ±(0.1% + 4 mΩ); ±1% for 10 MΩ steps.

Zero Resistance: <1 mΩ per decade, at dc; slightly higher for 7-10 decades; for HARS-X version; (<4 mΩ per decade for HARS-A and HARS-B)

Maximum Voltage to Case: 2000 V peak.

Operating Environment: +10 to 40°C, <80% RH.

Switch Type: 11 positions; "0"- "10"; multiple solid silver alloy contacts.

Switch Capacitance: <4 pF per switch.

Terminals: Low-thermal-emf beryllium-copper binding posts with standard 3/4 inch spacing, plus shield terminal; connections from the rear of the instrument are available with RO option.

Mechanical:

Model	Dimensions	Weight
1 decade	7.7 cm W x 7.7 cm H x 8.4 cm D (3" x 3" x 3.3")	0.45 kg (1.0 lb)
2-3 decades	31 cm W x 8.9 cm H x 10.2 cm D (12.2" x 3.5" x 4")	1.7 kg (3.8 lb)
4-5 decades	37.5 cm W x 8.9 cm H x 10.2 cm D	2.0 kg (4.3 lb)
6 decades	43.9 cm W x 8.9 cm H x 10.2 cm D (17.3" x 3.5" x 4")	2.2 kg (4.8 lb)
7 decades		2.4 kg (5.3 lb)
8 decades		2.6 kg (5.7 lb)
9 decades	48.3 cm W x 17.8 cm H x 19.7 cm D (19.0" x 7.0" x 7.8")	5.1 kg (11.2 lb)
10 decades		5.3 kg (11.7 lb)
11 decades		5.4 kg (11.9 lb)



IET LABS, INC. in the GenRad Tradition

534 Main Street, Westbury, NY 11590

IET cat/HARSX p1/02-24-06

www.ietlabs.com
TEL: (516) 334-5959 • (800) 899-8438 • FAX: (516) 334-5988

HARS-X Series

p. 2 of 2

SINGLE DECADE UNITS

Single decade units are available with resistance as low as 1 mΩ per step to as high as 10 MΩ per step. These units satisfy many system applications requiring only a single decade while maintaining all the quality features of the HARS series.

Each decade is enclosed in an aluminum case which can serve as a shield.

It may be panel mounted and integrated with additional units to form potentiometer circuits or other configurations.

Each unit consists of low inductance resistors in series, with a high performance solid silver alloy contact switch.



Single Decade HARS-X Unit

ORDERING INFORMATION

Model* (0.01% Accuracy)	Total Res. (Ω)	No. of Decades	Resolution (Ω)
HARS-X-1-0.001	0.01	1	0.001
HARS-X-1-0.01	0.1	1	0.01
HARS-X-1-0.1	1	1	0.1
HARS-X-1-1	10	1	1
HARS-X-1-10	100	1	10
HARS-X-1-100	1 k	1	100
HARS-X-1-1K	10 k	1	1 k
HARS-X-1-10K	100 k	1	10 k
HARS-X-1-100K	1 M	1	100 k
HARS-X-1-1M	10 M	1	1 M
HARS-X-1-10M	100 M	1	10 M
HARS-X-2-0.001	0.11	2	0.001
HARS-X-2-0.01	1.1	2	0.01
HARS-X-2-0.1	11	2	0.1
HARS-X-2-1	110	2	1
HARS-X-2-10	1.1 k	2	10
HARS-X-2-100	11 k	2	100
HARS-X-2-1K	110 k	2	1 k
HARS-X-2-10K	1.1 M	2	10 k
HARS-X-2-100K	11 M	2	100 k
HARS-X-2-1M	110 M	2	1 M
HARS-X-3-0.001	1.11	3	0.001
HARS-X-3-0.01	11.1	3	0.01
HARS-X-3-0.1	111	3	0.1
HARS-X-3-1	1.11 k	3	1
HARS-X-3-10	11.1 k	3	10
HARS-X-3-100	111 k	3	100
HARS-X-3-1K	1.11 M	3	1 k
HARS-X-3-10K	11.1 M	3	10 k
HARS-X-3-100K	111 M	3	100 k
HARS-X-4-0.001	11.11	4	0.001
HARS-X-4-0.01	111.1	4	0.01
HARS-X-4-0.1	1.111 k	4	0.1
HARS-X-4-1	11.11 k	4	1

Model* (0.01% Accuracy)	Total Res. (Ω)	No. of Decades	Resolution (Ω)
HARS-X-4-10	111.1 k	4	10
HARS-X-4-100	1.111 M	4	100
HARS-X-4-1K	11.11 M	4	1 k
HARS-X-4-10K	111.1 M	4	10 k
HARS-X-5-0.001	111.11	5	0.001
HARS-X-5-0.01	1.1111 k	5	0.01
HARS-X-5-0.1	11.111 k	5	0.1
HARS-X-5-1	111.11 k	5	1
HARS-X-5-10	1.1111 M	5	10
HARS-X-5-100	11.111 M	5	100
HARS-X-5-1K	111.11 M	5	1 k
HARS-X-6-0.001	1.111 11 k	6	0.001
HARS-X-6-0.01	11.1111 k	6	0.01
HARS-X-6-0.1	111.111 k	6	0.1
HARS-X-6-1	1.111 11 M	6	1
HARS-X-6-10	11.1111 M	6	10
HARS-X-6-100	111.111 M	6	100
HARS-X-7-0.001	11.111 11 k	7	0.001
HARS-X-7-0.01	111.1111 k	7	0.01
HARS-X-7-0.1	1.111 111 M	7	0.1
HARS-X-7-1	11.111 11 M	7	1
HARS-X-7-10	111.1111 M	7	10
HARS-X-8-0.001	111.111 11 k	8	0.001
HARS-X-8-0.01	1.111 111 M	8	0.01
HARS-X-8-0.1	11.111 11 M	8	0.1
HARS-X-8-1	111.111 11 M	8	1
HARS-X-9-0.001	1.111 111 11 M	9	0.001
HARS-X-9-0.01	11.111 111 1 M	9	0.01
HARS-X-9-0.1	111.111 111 M	9	0.1
HARS-X-10-0.001	11.111 111 11 M	10	0.001
HARS-X-10-0.01	111.111 111 1 M	10	0.01
HARS-X-11-0.001	111.111 111 11 M	11	0.001

* For less exacting applications, more economical tolerances are available:
 - use "A" for "X" in part number for 0.05% basic accuracy, in lieu of .01%
 - use "Q" for "X" in part number for 0.02% basic accuracy, in lieu of .01%
 - use "B" for "X" in part number for 0.1% basic accuracy, in lieu of .01%

OPTIONS
 - RM Rack mountable case for standard 19" rack
 - K Kelvin type 4-terminal binding posts
 - RO Rear output binding posts



HARS-L • HARS-LX • Series

p. 1 of 2

Highest accuracy version of the IET Labs resistance substituters for the most exacting calibration and test applications. The HARS-LX Series features a continuous rheostat as an option.

- High accuracy - 20 ppm
- High stability - 5 ppm/yr
- Low temperature coefficient - as low as 3 ppm/°C
- High performance solid silver contact switches
- Resistance from 10 mΩ to over 121 MΩ
- 1 mΩ or optional 20 μΩ resolution

- Hermetically sealed, low inductance resistors
- Precise fixed minimum resistance



HARS-LX Laboratory Standard Decade Resistance Substituter (shown with optional rheostat)

STANDARD MODELS

Series	HARS-L	HARS-LX
Description	Tight tolerance versions of the IET labs HARS-X Series for applications requiring a cost effective high performance resistance decade standard suitable for laboratory and field calibrations.	Highest performance decade resistance substituter with the tightest tolerance, stability, repeatability, and temperature coefficient.
Resistor type	Resistance wire for 0.1 steps and under; hermetically sealed, wirewound non-inductive resistors for 1 Ω steps and over.	
Range	10 mΩ up to 12.1 MΩ in 1 to 10 decades; (minimum may be lower for units with fewer decades)	
Resolution	1 mΩ discrete steps; 20 μΩ continuous resolution rheostat; 10 mΩ full scale, option RH.	
Initial Accuracy (absolute)	<±(25 ppm + 0.5 mΩ); at 23°C, no zero subtraction required, 4-terminal, "true-ohm" measurement, SI traceable.	<±(20 ppm + 0.5 mΩ); at 23°C, no zero subtraction required, 4-terminal, "true-ohm" measurement, SI traceable
Initial Adjustment Accuracy	±1 ppm for 10 kΩ steps; ±1.5 ppm for 100 kΩ steps; ±3 ppm for 1 MΩ steps. (For increased accuracy of the 1 Ω to 1 MΩ decades, individual resistors for these decades are trimmable.)	
Temperature Coefficient	<±20 ppm/°C for 10 Ω steps and under; <±5 ppm/°C for 100 Ω steps and over. <±50 μΩ/°C for wiring and switch resistance.	<±20 ppm/°C for 1 Ω steps and under; <±15 ppm/°C for 10 Ω steps; <±3 ppm/°C for 100 Ω steps and over; <±50 μΩ/°C for wiring and switch resistance.
Stability	<±(20 ppm + 0.5 mΩ)/year; <±5 ppm/year, typical.	
Minimum Resistance	10 mΩ ± 0.5 mΩ; limited by the lowest settable position, "1", of the 10 mΩ/step decade.	
Power Maximum	0.5 W per step up to 3 W total or 2 A max.	1 W per step up to 5 W total or 2 A max.
Calibration Conditions	Four-terminal measurement, low power, at 23°C; 30% to 60% RH.	
Switch Type	11 positions, "0"- "10", multiple solid silver alloy contacts, with short term contact resistance repeatability of <100 μΩ.	
Breakdown Voltage	1500 V peak to case	
Power Coefficient	<±1000 ppm/W for 0.1 Ω steps and under; <±400 ppm/W for 1 Ω steps; <±300 ppm/W for 10 Ω steps; <±100 pm/W for 100 Ω steps and over. <+50 μΩ/W for wiring and switch resistance.	



HARS-L • HARS-LX • Series

p. 2 of 2

Terminals: Low thermal emf beryllium copper binding posts with standard 3/4 inch spacing plus shield terminal; connection from the rear of the instrument is available as option RO.

Model	Dimensions	Weight
1 decades	7.7 cm W x 7.7 cm H x 8.4 cm D (3" x 3" x 3.3")	0.45 kg (1.0 lb)
2 - 4 decades	37.5 cm W x 8.9 cm H x 10.2 cm D (14.8" x 3.5" x 4")	1.7 kg (3.8 lb)
5 decades		2.0 kg (4.3 lb)

Model	Dimensions	Weight
6 and 7 decades	43.9 cm W x 8.9 cm H x 10.2 cm D (17.3" x 3.5" x 4")	2.2 kg (4.8 lb)
8 decades	48.3 cm W x 17.8 cm H x 19.7 cm D (19.0" x 7.0" x 7.8")	5.1 kg (13.0 lb)
9 and 10 decades		5.1 kg (13.0 lb)
11 decades	48.3 cm W x 32.5 cm H x 27.0 cm D (19.0" x 12.8" x 10.5")	9.1 kg (20.0 lb)

OPTIONAL RHEOSTAT



HARS-LX with Optional Rheostat Configuration

For high resolution applications, a 10 mΩ rheostat may be added for the lowest step. It is a 20 μΩ resolution "decade". In order to eliminate contact resistance and thermal emf, the HARS-LX integrates the rheostat as shown. In this way, the

wiper is in the low potential circuit, which is the high impedance lead. As a result, voltage and contact resistance effects are removed by being effectively added to the input impedance of the measuring instrument.

ORDERING INFORMATION

Model (Select L or LX accuracy grade)	Total Resistance (Ω)	No. of Decades	Resolution (Ω)
HARS-L(LX)-1-0.001	0.01	1	0.001
HARS-L(LX)-1-0.01	0.1	1	0.01
HARS-L(LX)-1-0.1	1	1	0.1
HARS-L(LX)-1-1	10	1	1
HARS-L(LX)-1-10	100	1	10
HARS-L(LX)-1-100	1 k	1	100
HARS-L(LX)-1-1K	10 k	1	1 k
HARS-L(LX)-1-10K	100 k	1	10 k
HARS-L(LX)-1-100K	1 M	1	100 k
HARS-L(LX)-1-1M	10 M	1	1 M
HARS-L(LX)-2-0.001	0.11	2	0.001
HARS-L(LX)-2-0.01	1.1	2	0.01
HARS-L(LX)-2-0.1	11	2	0.1
HARS-L(LX)-2-1	110	2	1
HARS-L(LX)-2-10	1.1 k	2	10
HARS-L(LX)-2-100	11 k	2	100
HARS-L(LX)-2-1K	110 k	2	1 k
HARS-L(LX)-2-10K	1.1 MΩ	2	10 k
HARS-L(LX)-2-100K	11 MΩ	2	100 k
HARS-L(LX)-3-0.001	1.11	3	0.001
HARS-L(LX)-3-0.01	11.1	3	0.01
HARS-L(LX)-3-0.1	111	3	0.1
HARS-L(LX)-3-1	1.11 k	3	1
HARS-L(LX)-3-10	11.1 k	3	10
HARS-L(LX)-3-100	111 k	3	100
HARS-L(LX)-3-1K	1.11 M	3	1 k
HARS-L(LX)-3-10K	11.1 M	3	10 k

Model (Select L or LX accuracy grade)	Total Resistance (Ω)	No. of Decades	Resolution (Ω)
HARS-L(LX)-4-0.001	11.11	4	0.001
HARS-L(LX)-4-0.01	111.1	4	0.01
HARS-L(LX)-4-0.1	1.111 k	4	0.1
HARS-L(LX)-4-1	11.11 k	4	1
HARS-L(LX)-4-10	111.1 k	4	10
HARS-L(LX)-4-100	1.111 M	4	100
HARS-L(LX)-4-1K	11.11 M	4	1 k
HARS-L(LX)-5-0.001	111.11	5	0.001
HARS-L(LX)-5-0.01	1.1111 k	5	0.01
HARS-L(LX)-5-0.1	11.111 k	5	0.1
HARS-L(LX)-5-1	111.11 k	5	1
HARS-L(LX)-5-10	1.1111 M	5	10
HARS-L(LX)-5-100	11.111 M	5	100
HARS-L(LX)-6-0.001	1.11111 k	6	0.001
HARS-L(LX)-6-0.01	11.1111 k	6	0.01
HARS-L(LX)-6-0.1	111.111 k	6	0.1
HARS-L(LX)-6-1	1.11111 M	6	1
HARS-L(LX)-6-10	11.1111 M	6	10
HARS-L(LX)-7-0.001	11.11111 k	7	0.001
HARS-L(LX)-7-0.01	111.1111 k	7	0.01
HARS-L(LX)-7-0.1	1.11111 M	7	0.1
HARS-L(LX)-7-1	11.1111 M	7	1
HARS-L(LX)-8-0.001	111.11111 k	8	0.001
HARS-L(LX)-8-0.01	1.211111 M	8	0.01
HARS-L(LX)-8-0.1	12.11111 M	8	0.1
HARS-L(LX)-9-0.001	1.2111111 M	9	0.001
HARS-L(LX)-9-K-RM	1.2111111 M	9	0.001
HARS-L(LX)-9-0.01	12.11111 M	9	0.01
HARS-L(LX)-10-0.001	12.111111 M	10	0.001
HARS-L(LX)-11-0.001	121.11111 M	11	0.001

OPTIONS

- RH 10 mΩ rheostat for lowest decades, 20 μΩ resolution.
- RO Rear output binding posts



High Resistance Decade Substituter

Replacement for

Biddle Megadek Series

HRRS Series

Economical high performance high resistance for all laboratory, test, and calibration needs.

- High accuracy - up to .01%
- High stability - up to 10 ppm/yr
- Excellent TC - as low as 5 ppm/°C
- High voltage versions available

- One to ten decades up to >1 TΩ
- Low voltage coefficient - as low as 0.2 ppm/V



6 Decade HRRS High Resistance Substituter

SPECIFICATIONS

Resistance Per Step	Decade Resistance	Accuracy Option			Max Voltage (Per Step)	Maximum Voltage (V)	Temp. Coefficient ±ppm/°C	Voltage Coefficient ±ppm/V	Stability ±ppm/year
		Q	B	F					
10 Ω	100 Ω	±0.01%	±0.03%	±0.1%	2.5 V	25	15	0	10
100 Ω	1 kΩ	±0.01%	±0.03%	±0.1%	8 V	80	5	0	10
1 kΩ	10 kΩ	±0.01%	±0.03%	±0.1%	23 V	230	5	0	10
10 kΩ	100 kΩ	±0.01%	±0.03%	±0.1%	70 V	700	5	0	10
100 kΩ	1 MΩ	±0.01%	±0.03%	±0.1%	230 V*	2000	5	0	10
1 MΩ	10 MΩ	±0.03%	±0.1%	±1%	1000 V*	2000	5	0.2	10
10 MΩ	100 MΩ	±0.03%	±0.1%	±1%	1000 V*	2000	15	0.2	50
100 MΩ	1 GΩ	±0.1%	±0.2%	±1%	1000 V*	2000	25	0.2	100
1 GΩ	10 GΩ	±0.2%	±0.5%	±1%	1000 V*	2000	50	1	500
10 GΩ	100 GΩ	±0.5%	±1%	±1%	1000 V*	2000	50	1	500
100 GΩ	1 TΩ	±0.5%	±1%	±3%	1000 V*	2000	200	5	500

* Subject to maximum of 2000 V (dc + ac peak);
See HRRS-5KV Series (p. 20) for higher voltage.

Zero Resistance: <3 mΩ per decade at dc.

Operating Conditions: 10°C to 40°C; <50% RH.

Terminals: Two five-way binding posts on 2 special, low leakage Kel-F insulating sockets and one metal ground post, for shielding, electrically connected to the case.

Model	Dimensions	Weight
3 decades	31.2 cm W x 8.9 cm H x 10.2 cm D (12.3" x 3.5" x 4.0")	1.4 kg (3.0 lb)
4 decades	37.5 cm W x 8.9 cm H x 10.2 cm D (14.8" x 3.5" x 4.0")	1.6 kg (3.5 lb)
5 decades		1.9 kg (4.0 lb)
6 and 7 decades	43.9 cm W x 8.9 cm H x 10.2 cm D (17.3" x 3.5" x 4.0")	2.0 kg (4.5 lb)

ORDERING INFORMATION

Model*	Total Resistance (Ω)	No. of Decades	Resolution (Ω)
HRRS-F-1-100G-5KV**	1 T	1	100 G
HRRS-B-2-1M	110 M	2	1 M
HRRS-B-2-10M	1.1 G	2	10 M
HRRS-B-2-100M	11 G	2	100 M
HRRS-B-2-1G	110 G	2	1 G
HRRS-B-2-10G-5KV**	1.1 T	2	10 G
HRRS-B-3-100K	111 M	3	100 k
HRRS-B-3-1M	1.11 G	3	1 M
HRRS-B-3-10M	11.1 G	3	10 M
HRRS-B-3-100M	111 G	3	100 M
HRRS-B-3-1G-5KV**	1.11 T	3	1 G
HRRS-B-4-10K	111.1 M	4	10 k
HRRS-B-4-100K	1.111 G	4	100 k
HRRS-B-4-1M	11.11 G	4	1 M
HRRS-B-4-10M	111.1 G	4	10 M
HRRS-B-4-100M-5KV**	1.111 T	4	100 M

* Replace "B" with "Q" for higher grade accuracy;
replace "B" with "F" for 1% accuracy.

**See HRRS-5KV (p. 20) Series for units with 1 TΩ maximum.

Model*	Total Resistance (Ω)	No. of Decades	Resolution (Ω)
HRRS-B-5-1K	111.11 M	5	1 k
HRRS-B-5-10K	1.1111 G	5	10 k
HRRS-B-5-100K	11.111 G	5	100 k
HRRS-B-5-1M	111.11 G	5	1 M
HRRS-B-5-10M-5KV**	1.1111 T	5	10 M
HRRS-B-6-10	11.1111 M	6	10
HRRS-B-6-100	111.111 M	6	100
HRRS-B-6-1K	1.11111 G	6	1 k
HRRS-B-6-10K	11.1111 G	6	10 k
HRRS-B-6-100K	111.111 G	6	100 k
HRRS-B-6-1M-5KV**	1.11111 T	6	1 M
HRRS-B-7-10	111.1111 M	7	10
HRRS-B-7-100	1.111111 G	7	100
HRRS-B-7-1K	11.11111 G	7	1 k
HRRS-B-7-10K	111.1111 G	7	10 k
HRRS-B-7-100K-5KV**	1.111111 T	7	100 k

Single Decade Version See HARS-X data sheet (p. 16)
OPTIONS:

- RM Rack mountable case for standard 19" rack
- K Kelvin type 4-terminal binding posts
- RO Rear outputs



IET LABS, INC. in the **GenRad** Tradition
534 Main Street, Westbury, NY 11590

www.ietlabs.com
TEL: (516) 334-5959 • (800) 899-8438 • FAX: (516) 334-5988

High Resistance 5 kV Decade Substituter

HRRS-5kV Series

p. 1 of 2

Economical high performance high resistance for all laboratory, test, and calibration needs.

- High accuracy - to .01%
- High stability - to 10 ppm/yr
- Excellent TC - as low as 5 ppm/°C
- Low current solid silver alloy contact switches
- One to seven decades up to 10 TΩ
- Low voltage coefficient - as low as 0.2 ppm/V

Replacement for
Biddle Megadek Series



7 Decade HRRS High Resistance Substituter

10 kV Available

SPECIFICATIONS

Decade Resistance	Resistance per step	Accuracy Option**			Max Voltage* per step	Maximum* Voltage (V)	Temp. Coefficient ±ppm/°C	Voltage Coefficient ±ppm/V	Stability ±ppm/year
		Q	B	F					
100 Ω	10 Ω	±0.01%	±0.03%	±0.1%	2.5 V	25 V	15	0	10
1 kΩ	100 Ω	±0.01%	±0.03%	±0.1%	8 V	80 V	5	0	10
10 kΩ	1 kΩ	±0.01%	±0.03%	±0.1%	23 V	230 V	5	0	10
100 kΩ	10 kΩ	±0.01%	±0.03%	±0.1%	70 V	700 V	5	0	10
1 MΩ	100 kΩ	±0.01%	±0.03%	±0.1%	230 V	2300 V	5	0	10
10 MΩ	1 MΩ	±0.03%	±0.1%	±0.5%	1000 V	5000 V	15	0.2	10
100 MΩ	10 MΩ	±0.03%	±0.1%	±1%	3500 V	5000 V	15	0.2	50
1 GΩ	100 MΩ	±0.1%	±0.2%	±1%	5000 V	5000 V	25	1.5	100
10 GΩ	1 GΩ	±0.2%	±0.5%	±1%	5000 V	5000 V	25	5	500
100 GΩ	10 GΩ	±0.5%	±1%	±1%	5000 V	5000 V	25	5	500
1 TΩ	100 GΩ	±0.5%	±1%	±3%	5000 V	5000 V	50	5	500
10 TΩ	1 TΩ	±3%	±5%	±10%	5000 V	5000 V	200	5	500

*(dc + ac peak)

Zero Resistance: <3 mΩ per decade at dc.

Operating Conditions: 10°C to 23°C; <50% RH.

Terminals: Two five-way binding posts on 2 special, low leakage, Kel-F insulating sockets and one metal ground post electrically connected to the case.

Dimensions: 43.2 cm W x 14.2 cm H x 13.5 cm D (17" x 5.6" x 5.3"); for 3 and 4 decades. 48.2 cm W x 22.2 cm H x 33 cm D (19" x 8.75" x 13") for 7, 8 and 9 decades. 48.2 cm W x 30.1 cm H x 21.6 cm D (19" x 12.2" x 8.5") for 10 and 11 decades.

Setting of value:

Standard: 11 positions, "0"- "10"; silver contacts, high voltage switch.

Binding Posts (optional): units use binding posts and shorting links in lieu of rotary switches to set resistance values.



HRRS-5KV High Resistance Substituter with binding posts; various and custom configurations are available



Single decade HRRS-5KV High Resistance Substituter with binding posts; various and custom configurations are available



ORDERING INFORMATION

Model*	Total Resistance (Ω)	No. of Decades	Resolution (Ω)
HRRS-B-1G-5KV	10 G	1	1 G
HRRS-B-1-10G-5KV	100 G	1	10 G
HRRS-F-1-100G-5KV	1 T	1	100 G
HRRS-B-2-1M-5KV	110 M	2	1 M
HRRS-B-2-10M-5KV	1.1 G	2	10 M
HRRS-B-2-100M-5KV	11 G	2	100 M
HRRS-B-2-1G-5KV	110 G	2	1 G
HRRS-B-2-10G-5KV	1.1 T	2	10 G
HRRS-B-2-100G-5KV	11.1 T	2	100 G
HRRS-B-3-100K-5KV	111 M	3	100 k
HRRS-B-3-1M-5KV	1.11 G	3	1 M
HRRS-B-3-10M-5KV	11.1 G	3	10 M
HRRS-B-3-100M-5KV	111 G	3	100 M
HRRS-B-3-1G-5KV	1.11 T	3	1 G
HRRS-B-3-10G-5KV	11.1 T	3	10 G
HRRS-B-4-10K-5KV	111.1 M	4	10 k
HRRS-B-4-100K-5KV	1.111 G	4	100 k
HRRS-B-4-1M-5KV	11.11 G	4	1 M
HRRS-B-4-10M-5KV	111.1 G	4	10 M
HRRS-B-4-100M-5KV	1.111 T	4	100 M
HRRS-B-4-1G-5KV	11.11 T	4	1 G
HRRS-B-5-1K-5KV	111.11 M	5	1 k
HRRS-B-5-10K-5KV	1.1111 G	5	10 k
HRRS-B-5-100K-5KV	11.111 G	5	100 k
HRRS-B-5-1M-5KV	111.11 G	5	1 M
HRRS-B-5-10M-5KV	1.1111 T	5	10 M
HRRS-B-5-100M-5KV	11.111 T	5	100 M

* Replace "B" with "Q" for higher grade accuracy;
replace "B" with "F" for 1% accuracy.

Model*	Total Resistance (Ω)	No. of Decades	Resolution (Ω)
HRRS-B-6-10-5KV	11.1111 M	6	10
HRRS-B-6-100-5KV	111.111 M	6	100
HRRS-B-6-1K-5KV	1.11111 G	6	1 k
HRRS-B-6-10K-5KV	11.1111 G	6	10 k
HRRS-B-6-100K-5KV	111.111 G	6	100 k
HRRS-B-6-1M-5KV	1.11111 T	6	1 M
HRRS-B-6-10M-5KV	11.1111 T	6	10 M
HRRS-B-7-10-5KV	111.1111 M	7	10
HRRS-B-7-100-5KV	1.111111 G	7	100
HRRS-B-7-1K-5KV	11.11111 G	7	1 k
HRRS-B-7-10K-5KV	111.1111 G	7	10 k
HRRS-B-7-100K-5KV	1.111111 T	7	100 k
HRRS-B-7-1M-5KV	11.11111 T	7	1 M
HRRS-B-8-1-5KV	111.11111 M	8	1
HRRS-B-8-10-5KV	1.1111111 G	8	10
HRRS-B-8-100-5KV	11.111111 G	8	100
HRRS-B-8-1K-5KV	111.11111 G	8	1 K
HRRS-B-8-10K-5KV	1.1111111 T	8	10 K
HRRS-B-8-100K-5KV	11.111111 T	8	100 K
HRRS-B-9-0.1-5KV	111.111111 M	9	0.1
HRRS-B-9-1-5KV	1.11111111 G	9	1
HRRS-B-9-10-5KV	11.1111111 G	9	10
HRRS-B-9-100-5KV	111.111111 G	9	100
HRRS-B-9-1K-5KV(0.6T)	1.11111111 T	9	1 k
HRRS-B-9-1K-5KV	1.11111111 T	9	1 k
HRRS-B-9-10K-5KV	11.1111111 T	9	10 K

Single Decade Version See HARS-X data sheet (p. 16)
OPTIONS:

- RM Rack mountable case for standard 19" rack
- K Kelvin type 4-terminal binding posts
- RO Rear outputs
- BP Binding posts in lieu of rotary switches
- 10kV10 kV maximum for applicable decades



High Power Decade Resistance Substituter

HPRS Series

Economical high performance high power resistance for all laboratory, test, and calibration needs.

- Resistance from 1 mΩ to 10 MΩ
- 1 to 9 decades
- 0.5% or 1% accuracy
- 1000 V rating, higher available

- Power of 225 W/decade, 250 W max. or higher
- Rack mounting available
- Special and custom configurations



6 Decade Benchtop High Power Resistance Substituter

SPECIFICATIONS

Resistance per step	Decade Total (Ω)	Max. * Current per decade (A)	Max. * Power per step (W)	Temperature Coefficient (ppm/°C)
1 mΩ	0.009	6	0.036	50
10 mΩ	0.09	6	0.36	50
100 mΩ	0.9	6	3.6	20
1 Ω	9	5	25	50
10 Ω	90	1.5	25	50
100 Ω	900	0.5	25	50
1 kΩ	9k	0.15	25†	50
10 kΩ	90k	0.05†	25†	50
100 kΩ	900 k	V limit†	V limit†	20
1 MΩ	9M	V limit†	V limit†	10

* Subject to 250 W max. per unit.

† Subject to 1000 V (dc + ac peak) max.

Accuracy:

Option C: ±(0.5% + 20 mΩ) after zero subtraction; SI traceable.
Option F: ±(1.0% + 20 mΩ) after zero subtraction; SI traceable.

Zero Resistance: <5 mΩ per decade, at dc;

Type of Resistor: Resistance wire for 0.1 Ω and under; film power resistors for 1 Ω to 100 kΩ steps; low inductance wirewound resistors for 1 MΩ steps.

Terminals: Two five-way binding posts and one ground post electrically connected to case.

Model	Dimensions	Weight
6 decades	43.9 cm W x 8.9 cm H x 10.2 cm D (17.3" x 3.5" x 4")	2.2 kg (4.8 lb)
7 decades		2.4 kg (5.3 lb)
8 decades		2.6 kg (5.7 lb)
9 decades	48.3 cm W x 17.8 cm H x 19.7 cm D (19.0 x 7.0 x 7.8")	5.1 kg (11.2 lb)

ORDERING INFORMATION

Model* (1% Accuracy)	Total Resistance (Ω)	No. of Decades	Resolution (Ω)
HPRS-F-3-0.001	1	3	0.001
HPRS-F-3-0.01	10	3	0.01
HPRS-F-3-0.1	100	3	0.1
HPRS-F-3-1	1 k	3	10
HPRS-F-3-10	10 k	3	10
HPRS-F-3-100	100 k	3	100
HPRS-F-3-1K	1 M	3	1 k
HPRS-F-3-10K	10 M	3	10 k
HPRS-F-4-0.001	10	4	0.001
HPRS-F-4-0.01	100	4	0.01
HPRS-F-4-0.1	1 k	4	0.1
HPRS-F-4-1	10 k	4	1
HPRS-F-4-10	100 k	4	10
HPRS-F-4-100	1 M	4	100
HPRS-F-4-1K	10 M	4	1 k
HPRS-F-5-0.001	100	5	0.001
HPRS-F-5-0.01	1 k	5	0.01
HPRS-F-5-0.1	10 k	5	0.1

*For 0.5% accuracy substitute "C" for "F" in the part number.

Model* (1% Accuracy)	Total Resistance (Ω)	No. of Decades	Resolution (Ω)
HPRS-F-5-1	100 k	5	1
HPRS-F-5-10	1 M	5	10
HPRS-F-5-100	10 M	5	100
HPRS-F-6-0.001	1 k	6	0.001
HPRS-F-6-0.01	10 k	6	0.01
HPRS-F-6-0.1	100 k	6	0.1
HPRS-F-6-1(HPRS-150)	1 M	6	1
HPRS-F-6-10	10 M	6	10
HPRS-F-7-0.001	10 k	7	0.001
HPRS-F-7-0.01	100 k	7	0.01
HPRS-F-7-0.1(HPRS-200)	1 M	7	0.1
HPRS-F-7-1	10 M	7	1
HPRS-F-8-0.001	100 k	8	0.001
HPRS-F-8-0.01	1 M	8	0.01
HPRS-F-8-0.1(HPRS-200W)	10 M	8	0.1
HPRS-F-9-0.001	1 M	9	0.001
HPRS-F-9-0.01	10 M	9	0.01

OPTIONS

- RM Rack mountable case for standard 19" rack
Programmable Version See PRS data sheet (p. 17)



PRS • PCS • PLS • PRTD • Series p. 1 of 4

Broad range of laboratory grade decade substituters for applications requiring a cost

effective programmable-impedance unit controlled manually and by a computer.

RESISTANCE • RTD • CAPACITANCE • INDUCTANCE



- Multiple control mode:
Thumbwheel switch
IEEE-488.1
IEEE-488.2 (w/SCPI)
RS232C (w/SCPI)
- National Instruments LabVIEW hardware and software tools available
- Special RTD and custom configurations
- High power versions
- Programmable "open circuit" and "short circuit" states optional



Dual PZS Resistance and Capacitance Substituter

OPTIONS AND CONFIGURATIONS



Model PRS-201 Resistance Substituter

Choice of Performance:
 PRS-200 Series - economical 1% accuracy
 PRS-201 Series - laboratory 0.1% accuracy
 PRS-202 Series - high accuracy to 0.01%
 PRTD Series - programmable RTD simulation.

Package Configuration: Convenient standard 19" rack mounting or more portable benchtop versions are available. Both single and dual units are available.

Low thermal emf: Specially selected relays along with tellurium copper binding posts insure minimum thermal emf drift.

High Power: Power up to 100's of watts and high current options are available.

Combinations: Dual or combination resistance-capacitance-inductance models may be configured.

Special Requirements: High voltage nonstandard values, ultra low tempco or special programming needs can be accommodated.

Rear Outputs: Single or dual front and rear outputs are available with option RO.

Wide choice of impedance ranges: resistance, capacitance and inductance of up to 10 decades may be specified. Resistance may range from 1 mΩ to 100 MΩ.

PRTD: Low resistance versions with a fixed minimum resistance setting (4 Ω or specified by customer) are suitable for RTD (Resistance Temperature Detector) simulations. This design virtually eliminates the effect of zero resistance and relay contact resistance, providing the specified absolute accuracy over its entire range.

High Power Options: Power dissipation requirements of up to tens of Watts can be accommodated.

Short-Circuit (SC) and Open-Circuit (OC) Options: Optional short-circuit and open-circuit modes of operation. These states are controlled only in the REMOTE programming mode.

OC or Open Circuit operation gives the user an open circuit immediately in series with the HI binding post. SC or Short Circuit operation gives the user a short circuit across the HI and the LO binding posts. The short circuit impedance is very small, <20 mΩ or as low as 5 mΩ. This is lower than the regular zero resistance setting. In both these cases, the underlying resistance setting is unaffected and may still be controlled.



Programmable Resistance Temperature Detector (PRTD) Substituter

Digital Display

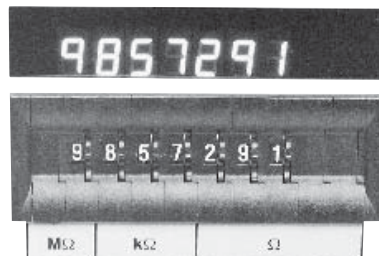

D-Option: Shows the commanded value - either thumbwheel or remote setting on a matching LED display above the thumbwheel switches. This is useful for confirming or monitoring the selected command value, remote or local. This option requires the Rack Mount RM option.



PRS • PCS • PLS • PRTD • Series p. 2 of 4

REMOTE CONTROL AND PROGRAMMING

Control Options:

Thumbwheel: Standard feature on all models.

BCD: (Binary Coded Decimal): Use external digital I/O lines to set decade values individually. Requires 4 TTL lines per decade. The user provides his own control circuitry

IEEE.1: Our original computer interface which supports the IEEE-488.1 or IEEE-1978 protocol is still available to allow you to maintain compatibility with your legacy hardware / software investment. This may also be a more economical solution for your control needs

NEW! IEEE: This is the most popular, worldwide interface standard for test and measurement equipment. With this option, the PRS is compliant with IEEE-488.2 and SCPI 1994.0. Features *IDN and cal date query, allowing you to improve your instrument and calibration tracking capabilities. GPIB addressing is controlled via DIP switches or commands on the GPIB bus.

NEW! RS232: This interface conforms to EIA-STD-RS-530; with a 25 pin DTE interface. Choose from factory configurable RS232 or RS422/RS485 differential modes.

The PRS is a standard DTE device in RS232 mode. Typical connection to a controlling computer is made via a null-modem cable. This is the default mode if not specified.

Specify RS422/485 mode when the PRS is in a remote location or when communications port capacity is at a premium. The RS422/485 specification uses differential signalling to increase transmission distances and to reduce communications errors in noisy environments. When in 485 mode, the PRS is a listen-only device and configurable to addresses 0-15. The internal 422/485 mode eliminates the need for external signal adapters on the PRS.

When equipped with any remote control functionality, the PRS front panel switch determines if REMOTE mode is enabled. Regardless of remote control type, setting the front panel switch to the LOCAL position always disables the remote control "set" value. Use of the IEEE GTL (go-to-local) command message returns the PRS to LOCAL mode and the PRS output value to the thumbwheel setting. GTL is an IEEE specific function and not applicable to Serial or BCD equipped units.

Supported commands include: *IDN?, *CLS, *ESE, *ESE?, *ESR?, *IDN?, *OPC, *OPC?, *PSC, *PSC?, *RCL, *RST, *SAV, *SRE, *SRE?, *STB, *TRG, *TST? and *WAI.

When using the PRS in an environment where traceability is required, test software can query the '*IDN' and 'CALibrate:DATE' registers at the beginning of each test sequence to record equipment serial numbers and check the calibration date against the current date.

A typical test sequence might include:

```

Init the instrument          *RST
retrieve S/N & caldate *IDN?;CAL:DATE?

Loop Begin

    set PRS value            SOURCE:DATA 000050000000
    check for errors        SYST:ERR? or *STB?
    make test meas....

Loop End

Return to known state      SOURCE:DATA 000000000000
Send Go-To-Local cmd
    
```

NATIONAL INSTRUMENTS SOFTWARE AND HARDWARE TOOLS

GPIB instruments are the most popular, worldwide standard for test and measurement systems. To close the loop for your remote control system needs, IET Labs can supply National Instruments hardware and software GPIB solutions for almost every desktop, laptop, industrial PC, workstation, and interface bus including PCI, CompactPCI, PCMCIA, USB, serial, 1394 and Ethernet.

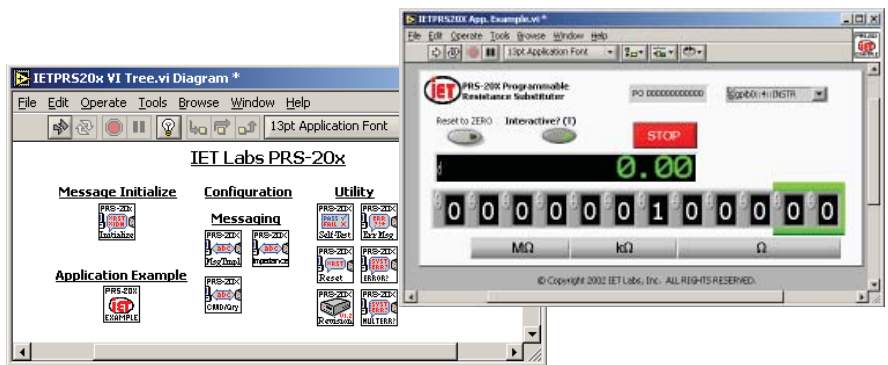
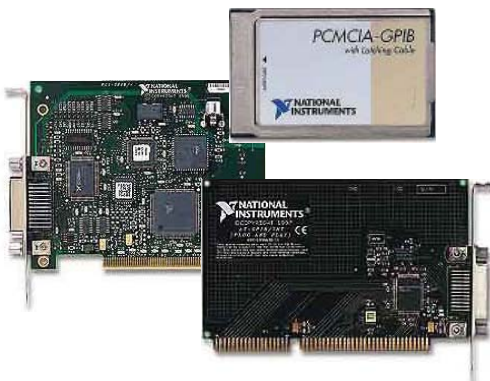

LabVIEW instrument drivers are available for units equipped with GPIB or RS232C options. These drivers are written based on the National Instruments instrument template, using VISA handles and standard initialize, config and query functions.

Contact us if you need help creating more complex test and/or measurement solutions based on interconnecting multiple/different IET Labs instruments.



PRS • PCS • PLS • PRTD • Series p. 3 of 4

The remote output value is set by sending a 'SOURCE:DATA' command followed by a string that represents the digits as they would be selected using the thumbwheels. Leading and trailing zeros are required to set each decade properly; the decimal point is not used.

For example; the PRS-202 has a least significant digit value of 0.01 Ohms and a remote logic maximum of 12 command decades. To set a value of 500,000.45 Ohms, the command string would be:

SOURCE:DATA 000050000045

The PRS-201 has a least significant digit value of 0.1 Ohms and a remote logic maximum of 10 command decades. To set a value of 2,500.8 Ohms, the command string would be:

SOURCE:DATA 000025008

Request the LabVIEW drivers to quickly integrate the PRS into your test environment. These drivers are built based on the NI driver template, and include a virtual front panel application. The LabVIEW runtime engine is included with the drivers for simple remote control operation.

SPECIFICATIONS

Accuracy: The accuracy, indicated in the chart below, applies after subtraction of the "zero setting" residual impedance.

Accuracy (PRTD): Absolute accuracy, indicated below, applies without requiring subtraction of "zero setting" residual impedance.

Min. Setting (PRTD): 4 Ω or customer specified.

Thermal emf: < 15 μV; < 10 μV, typical.

Terminals:

Four low emf gold plated tellurium copper 5-way binding posts are used for HI and LO terminal pairs for CURRENT and SENSE. GND binding post is connected to the case, to the chassis ground and to the earth ground. Rear outputs are available with RO option.

Switching time: <4 ms per change; <7 ms for ≤0.05% units.

Power Requirements: 105-125 V or 210-250 V (internally switchable for PRS 202 series) 50-60 Hz; 10 W nominal; battery pack available; see BP-511 Series.

Remote Control Input Options:

IEEE.1: Original GPIB interface; standard 24 pin connector conforms to IEEE-488.1-1978; configurable address from 0 to 30

IEEE: GPIB standard 24 pin connector, conforms to IEEE-488.2; SCPI 1994.0 command set; Hardware or software configurable addressing range of 0 to 30. Default IEEE option if ".1" or ".2" choice not specifically noted.

RS232: NEW - 25 pin male DTE interface conforms to EIA-STD-RS-530; SCPI 1994.0 command set; data rates from 300 to 115200 bps.

BCD: Parallel, CMOS positive true logic

Dimensions: Bench model: 22 cm W x 12 cm H x 24 cm D (8.5" x 4.44" x 9.25") Rack model: Panel: 48.3 cm W x 13.2 cm H (19" x 5.2"); behind panel: 42.7 cm W x 12.4 cm H x 31.5 cm D (16.8" x 5.2" x 12.4"); in front of panel: 3.8 cm (1.5").

Weight: Bench model: 2.0 kg (4.5 lb); Rack model: 4.5 kg (10 lb); Dual rack mount model: 6.4 kg (14 lb); weight specifications are nominal.

Interface: IEEE-488-1978, or parallel BCD interface; front panel switch selects REMOTE (digital interface) or LOCAL (front panel thumbwheel) operation. See pp. 46-49 for IEEE-488 interface software and hardware, check for 2 intervals.

STANDARD MODELS

Model	PRS-200	PRS-201	PRS-200W	PRS-201W	PRS-202	PRS-202W	PRTD	PCS-300	PCS-301	PLS-400	PLS400A
Type	Resistance	Precision Resistance	Wide Range Resistance	Wide Range Precision Resistance	High Precision Resistance	Wide Range High Precision Resistance	Precision Absolute Value Resistance	Precision Capacitance	Wide Range Capacitance	Range	Inductance
Accuracy	1% +70 mΩ	0.1%+ 30 mΩ	1%+ 70 mΩ	0.1%+ 30 mΩ	0.01% to 0.05% + 15 mΩ		.02 - .05% + 10 mΩ	4% + 5 pF	1% + 3 pF	2%	
Decades	7		9		7	9	6 or more	6		4	3
Range	0 - 9,999,999 Ω		0 - 99,999,999.9 Ω		0 - 9,999,999 Ω	0 - 99,999,999.9 Ω	4-10,003.99 Ω	0 - 99,999.9 μF		0 - 9,999 H	0 - 999 mH
Resolution	1 Ω		0.1 Ω		1 Ω	0.1 Ω	0.01 or 0.001 Ω	100 pF		1 mH	1 mH
Type of Components	Resistance wire for 0.1 Ω steps and under; metal film for 1 Ω steps and over.				Resistance wire for 0.1 Ω steps and under; wirewound, sealed non-inductive resistors for 1 Ω steps and over.			100-900 pF: Mica 0.001-0.009 μF: Polystyrene 0.01-0.9 μF: Polycarbonate 1-9 μF: Polyester 10-90 μF: Polarized tantalum		Toroidal inductors See inductance Substituters (page 9) for specifications	
Max. Load*	0.5 A, 200 V (dc + ac peak), 0.2 W/step, 2 W unit, whichever applies first.*				3 A, 200 V (dc + ac peak), 0.5 W/step, 4.5W/unit, whichever applies first.*			100 V (20 V for 10-100 μF)		See page 12	
Residual Impedance	<450 mΩ See page 12		<600 mΩ		<100 mΩ	<140 mΩ typically <100 mΩ	Absolute Value	7 pF, typical; higher w/ Rear Output			

* These specifications are dynamic switching limits. The maximum voltage, power, or current which may be applied at any particular resistance setting may be higher as long as the setting is unchanged, or the unit is switched dry.



ORDERING INFORMATION

STANDARD MODELS

PRS-200	Programmable Resistance Substituter
PRS-201	Programmable Precision Resistance Substituter
PRS-200W	Programmable Wide Range Resistance Substituter
PRS-201W	Programmable Wide Range Precision Resistance Sub
PRS-202	Programmable High Precision Resistance Substituter
PRS-202W	Programmable Wide Range High Precision Resistance Sub
PCS-300	Programmable Capacitance Substituter
PCS-301	Programmable Precision Capacitance Substituter
PLS-400	Programmable Wide Range Inductance Substituter
PLS-400A	Programmable Inductance Substituter
PRTD Models	Programmable RTD Simulator

INTERFACE OPTIONS

-IEEE.1 Option	IEEE-488.1 Interface
-IEEE Option	IEEE-488.2 Interface
-RS232 Option	Serial interface
-BCD Option	BCD Interface

OTHER OPTIONS

-RM Option	Rack mount
-RO Option	Rear output
-D Option	Digital display of command
-SC Option	Short circuit option
-OC Option	Open circuit option
-220V	220 V Operation
BP-511	Battery pack, AC source, 115 V, 60 Hz, 40 W

National Instruments/LabVIEW Related

PZS-LV61	PZS Series LabVIEW 6.1 driver
----------	-------------------------------

CONTROLLER OPTIONS

NI-778032-01	GPIB controller for PCI for Windows 2000/XP
NI-777073-01	GPIB controller for PCI for Windows NT
NI-777158-01	GPIB controller for PCI for Windows Me/9x
NI-778034-02	GPIB controller for PCMCIA for Windows 2000/XP, with 2 m GPIB cable
NI-777332-02	GPIB controller for PCMCIA for Windows NT, with 2 m GPIB cable
NI-777332-02	GPIB controller for PCMCIA for Windows Me/9x, with 2 m GPIB cable
NI-778416-01	GPIB-USB-B, NI-488.2 for Windows 2000/XP/Me/ 98(English&Japan)
NI-777641-02	PCI-485/2, Enhanced COM Driver for Windows 2000/NT/9x, 2 Ports (use with RS232 option)
NI-777387-01	PCI-DIO-96 Digital I/O Board and NI-DAQ for Win 2000/NT/9x/MAC (use with BCD option)

For other computers or Operating Systems Consult IET

LabVIEW Software Systems Consult National Instruments

GPIB CABLES

CBL-488-1	1 meter IEEE-488 cable
CBL-488-2	2 meter IEEE-488 cable
CBL-488-4	4 meter IEEE-488 cable
CBL-488-X	Custom cables any length

OPTIONAL MODELS

In order to satisfy any unique requirements for programmable substituters, generate a part number from the table below.

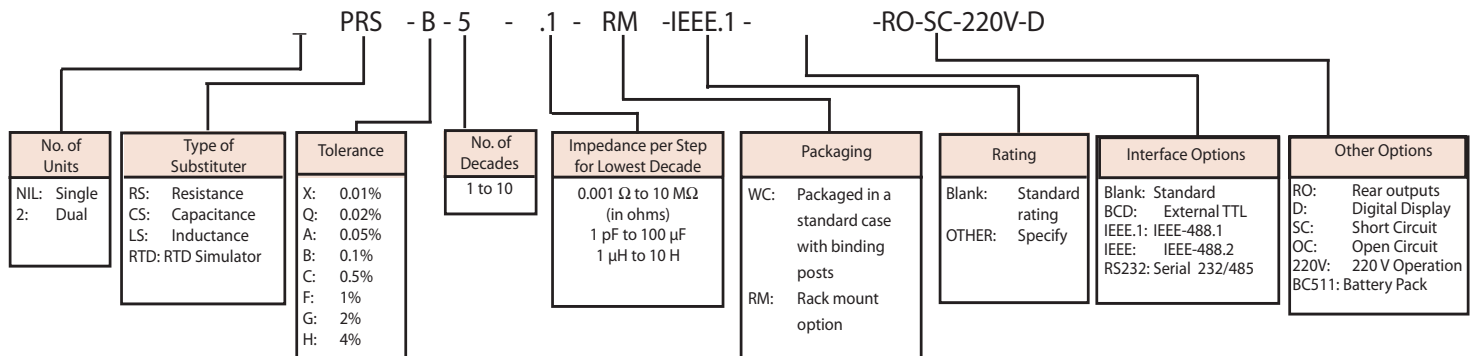

(i.e.: 0 - 9,999.9 Ω, 1%, 0.1 Ω steps, rack mounted PRS with IEEE-488.1 control, rear outputs, short circuit operation, 220 V AC operating voltage and digital display)



SRL Series

Highest performance, very low temperature coefficient, highest stability sealed resistance standards.

- No oil bath required
- Very stable - 2 ppm/yr, typical
- Extremely low TC: <2 ppm total for 18-28°C range
- Optional values & combination units
- Very wide rang - 1 mΩ to 10 TΩ
- Optional transit case

Extremely high accuracy & stability, sealed, on site resistance standard requiring no oil or temperature bath.

SPECIFICATIONS

Model*	Nominal Value	Adjustment Accuracy (±ppm)	Calibration Uncertainty (±ppm)	Stability 12 months (±ppm)		Max Resistance Change from 23°C	Max Current	Max Voltage (V)	Current Limit for Accuracy † (mA)
				max	typ.				
SRL-0.001	1 mΩ	50	50	50	-	20 ppm/°C	10 A	0.01	-
SRL-0.0019	1.9 mΩ	50	50	50	-	20 ppm/°C	10 A	0.02	-
SRL-0.002	2 mΩ	50	50	50	-	20 ppm/°C	10 A	0.02	-
SRL-0.01	10 mΩ	50	20	50	-	20 ppm/°C	10 A	0.1	-
SRL-0.019	19 mΩ	50	20	50	-	20 ppm/°C	10 A	0.2	-
SRL-0.1	100 mΩ	10	10	50	-	20 ppm/°C	3 A	0.3	-
SRL-0.19	190 mΩ	10	10	50	-	20 ppm/°C	3 A	0.6	-
SRL-1	1 Ω	2	1	8	2	3 ppm tot	500 mA	0.5	256
SRL-1.9	1.9 Ω	2	1	8	2	3 ppm tot	200 mA	0.38	186
SRL-10	10 Ω	2	1	8	2	3 ppm tot	100 mA	1	63
SRL-19	19 Ω	2	1	8	2	3 ppm tot	74 mA	1.4	45
SRL-25	25 Ω	2	1	8	2	3 ppm tot	63 mA	1.6	40
SRL-30	30 Ω	2	1	8	2	3 ppm tot	57 mA	1.7	36.5
SRL-50	50 Ω	2	1	8	2	3 ppm tot	44 mA	2.2	28
SRL-100	100 Ω	2	1	6	2	3 ppm tot	32 mA	3.2	20
SRL-190	190 Ω	2	1	6	2	3 ppm tot	24 mA	4.5	14.5
SRL-350	350 Ω	2	1	6	2	3 ppm tot	17 mA	5.95	10.7
SRL-400	400 Ω	2	1	6	2	3 ppm tot	15.8 mA	6.3	10
SRL-1K	1 kΩ	2	1	6	1	3 ppm tot	10 mA	10	6
SRL-1.9K	1.9 kΩ	2	1	6	1	2 ppm tot	7.4 mA	14	4.6
SRL-10K	10 kΩ	2	1	4	1	1.5 ppm tot	3 mA	30	2
SRL-19K	19 kΩ	2	1	4	1	2 ppm tot	2.3 mA	28	1.4
SRL-100K	100 kΩ	2	1	6	1.5	2 ppm tot	1 mA	100	0.63
SRL-190K	190 kΩ	2	1	8	2	2 ppm tot	0.5 mA	100	0.45
SRL-1M	1 MΩ	2	2	8	2	2 ppm tot	0.1 mA	100	-
SRL-1.9M	1.9 MΩ	2	2	9	2	3 ppm tot	0.053 mA	100	-
SRL-10M	10 MΩ	2	2	9	2	3 ppm tot	0.030 mA	300	-
SRL-19M	19 MΩ	2	9	10	2	4 ppm tot	0.016 mA	300	-
SRL-100M	100 MΩ	10	9	20	-	2 ppm/°C	10 μA	1000	-
SRL-1G	1 GΩ	0.1%	100	200	100	20 ppm/°C	-	5000	-
SRL-10G	10 GΩ	0.1%	200	500	300	25 ppm/°C	-	5000	-
SRL-100G	100 GΩ	0.2%	1000	500	300	25 ppm/°C	-	5000	-
SRL-1T	1 TΩ	0.5%	0.25%	500	300	50 ppm/°C	-	5000	-
SRL-1.9T	1.9 TΩ	0.7%	0.7%	1000	500	100 ppm/°C	-	5000	-
SRL-10T	10 TΩ	0.7%	0.7%	2000	1000	100 ppm/°C	-	5000	-

† Add 1 ppm error when test current value exceeds Current Limit.

Retrace: Permanent shift in resistance value is <2 ppm for 23°C to 0°C to 23°C cycle, and 23°C to 40°C to 23°C cycle; applies for 1 Ω to 19 MΩ.

Calibration Report: Initial SI traceable calibration data provided in 0.5°C increments for temperature range of 18°C to 28°C.

Terminals: Four 5-way binding posts for 4-terminal measurement for 190 kΩ and under; two binding posts for 1 MΩ and over. The binding posts are constructed of tellurium copper for low thermal emf and low resistance. A case ground terminal is also provided. Guard terminal for 100 MΩ and over. DMM direct input compatibles available; bnc, Triax, and custom connectors available.

Calibration Conditions: Four-wire Kelvin measurements, low power, at 23°C; two wire for 1 MΩ and over. Traceable to SI.

Temperature Range: 18°C to 28°C.

Storage Temperature: 0°C to 40°C.

Dimensions: 8.6 cm H x 10.5 cm W x 12.7 cm D (3.4" x 4.15" x 5").

Weight: 0.73 kg (1.6 lb).

Transit Case: Optional Model SRC-100 lightweight transit case with handle, suitable for transporting and storing two units. The case provides mechanical protection and insulation from temperature changes during transportation or shipping.



SRL-1 High Accuracy Resistance Standard Requiring No Temperature Bath

- Combination units in single housing available
- Direct plug-in units for DMM calibration available
- Optional Transit Case

Improved specifications for high resistors



Standard Resistance Reference or Working Standards

SRX • SRA • SRC • Series

Economical high performance resistance standards.

- Very stable - up to 10 ppm/yr
- Excellent TC - as low as 1 ppm/°C
- Rugged
- Wide range of values - 1 mΩ to 10 TΩ
- Optional values available
- Optional transit case
- SRX series available at 5000 V

SRX/SRA SERIES

Designed for use as a reference or working standard in industrial, research, and educational laboratories.

SRC SERIES

Economical high resistance, high voltage standards for applications requiring values up to 10 TΩ

SRX Maximum Voltage: 5000 V.



SRA Series Resistance Standard

SPECIFICATIONS

Model	Nominal Value (Ω)	Adjustment to Nominal (ppm)		Calibration Uncertainty (ppm)	Stability 1 year (ppm)		Tempco (ppm/°C)		Power Coef. (ppm/mW)		Max. Power (W)		Max. Voltage (V)		Max. Current	
		SRX	SRA		SRX	SRA	SRX	SRA	SRX	SRA	SRX	SRA	SRX	SRA	SRX	SRA
0.001	0.001	200	500	200	50	100	20	20	0.1	0.1	0.2	0.2	0.015	0.015	14 A	14 A
0.0019	0.0019	200	500	200	50	100	20	20	0.1	0.1	0.38	0.38	0.03	0.03	14 A	14 A
0.002	0.002	200	500	200	50	100	20	20	0.1	0.1	0.2	0.2	0.02	0.02	10 A	10 A
0.01	0.01	200	500	100	50	100	20	20	0.1	0.1	2	2	0.15	0.15	14 A	14 A
0.019	0.019	200	500	100	50	100	20	20	0.1	0.1	3.8	3.8	0.3	0.3	14 A	14 A
0.1	0.1	200	500	20	50	100	20	20	0.1	0.1	1	1	0.3	0.3	3 A	3 A
0.19	0.19	200	500	20	50	100	20	20	0.1	0.1	1.7	1.7	0.6	0.6	3 A	3 A
1	1	20	100	10	20	50	10	20	0.5	1	0.25	1	0.5	1	0.5 A	1 A
1.9	1.9	20	100	10	20	50	10	20	0.5	1	0.25	1	0.7	1.4	0.36 A	0.73 A
10	10	10	30	5	10	18	3	5	0.15	0.25	0.1	1	1	3	0.1 A	0.3 A
19	19	10	30	5	10	18	3	5	0.15	0.25	0.1	1	1.4	4.4	70 mA	23 mA
50	50	10	20	5	10	15	1	3	0.05	0.15	0.1	1	2.3	7	45 mA	140 mA
100	100	10	20	5	10	15	1	3	0.05	0.15	0.1	1	3	10	30 mA	0.1 A
190	190	10	20	5	10	15	1	3	0.05	0.15	0.1	1	4.4	14	23 mA	70 mA
1K	1 k	10	20	2	10	15	1	3	0.05	0.15	0.1	1	10	30	10 mA	30 mA
1.9K	1.9 k	10	20	2	10	15	1	3	0.05	0.15	0.1	1	14	42	7 mA	22 mA
10K	10 k	10	20	2	10	15	1	3	0.05	0.15	0.1	1	30	100	3 mA	10 mA
19K	19 k	10	20	2	10	15	1	3	0.05	0.15	0.1	1	43	140	2.2 mA	7 mA
100K	100 k	10	20	2	10	15	1	3	0.05	0.15	0.1	1	100	300	1 mA	3 mA
190K	190 k	10	20	2	10	15	1	3	0.05	0.15	0.1	1	140	440	0.7 mA	2.2 mA
1M	1 M	20	50	5	15	20	3	10	0.15	0.5	0.1	1	316	1000	0.3 mA	1 mA
1.9M	1.9 M	20	50	5	15	20	3	10	0.15	0.5	0.1	0.5	440	1000	0.23 mA	0.5 mA
10M	10 M	20	50	10	20	50	5	10	0.25	0.5	0.1	0.1	2000	2000	0.1 mA	0.1 mA
19M	19 M	20	50	10	20	50	5	15	0.7	0.7	0.05	0.05	5000	5000	50 μA	50 μA
100M	100 M	50	100	15	20	100	5	25	1.2	1.2	0.01	0.01	5000	5000	10 μA	10 μA

SRC-190M	190 M	0.1%	30	500	25
SRC-1G	1 G	0.5%	100	500	50
SRC-1.9G	1.9 G	0.5%	100	500	50
SRC-10G	10 G	0.5%	200	500	50
SRC-19G	19 G	0.5%	500	500	50
SRC-100G	100 G	0.5%	900	500	50
SRC-190G	190 G	1%	900	500	50
SRC-1T	1 T	2%	2500	500	100
SRC-1.9T	1.9 T	2%	2500	1000	200

GENERAL

Test Conditions: Four-terminal Kelvin measurements, low power, at 23°C; two-terminal for 1 MΩ and over. Initial calibration data traceable to NIST is provided.

Terminals: SRX: Four 5-way binding posts for 4-terminal measurement for 190 kΩ and under; two binding posts for 1 MΩ and over. The binding posts are constructed of tellurium copper for low thermal emf and low resistance. A case ground terminal is also provided. Triax and bnc terminals are also available.

SRC: Additional GUARD terminal is provided.

Dimensions: 8.6 cm H x 10.5 cm W x 12.7 cm D (3.4" x 4.15" x 5").

Transit Case: Optional Model SRC-100 lightweight transit case with handle, suitable for transporting and storing two units. The case provides mechanical protection and insulation from temperature changes during transportation or shipping.

Operating Temperature Range: 15 to 30°C.

SRX Series Maximum Voltage: 5000 V.

Combination units in single housing available.



IET LABS, INC. in the **GenRad** Tradition
534 Main Street, Westbury, NY 11590

www.ietlabs.com
TEL: (516) 334-5959 • (800) 899-8438 • FAX: (516) 334-5988

VRS-100 • Series

An economical set of precision high resistance standards designed for testing megohmmeters

or other instruments; 9 or 10 values up to 10 TΩ with special Kel-F isolation.

- Set of nine resistors - 1 kΩ, 10 kΩ, 100 kΩ, 1 MΩ, 10 MΩ, 100 MΩ, 1 GΩ, 10 GΩ, 100 GΩ, (1 TΩ and 10 TΩ optional), open circuit
- Nonstandard value sets up to 10 TΩ
- High Accuracy - up to 20 ppm
- Maximum voltage: up to 5000 V (higher voltages are available)
- Excellent TC - up to 5 ppm/°C
- Excellent stability - up to 10 ppm/year



Model VRS-100 High Resistance Standards, binding post version

- Two user versions available:
binding posts
rotary switch



Model VRS-100 High Resistance Standards, rotary switch version, with guard and case ground

SPECIFICATIONS

Nominal value Ω	Max Voltage V	Adjustment Accuracy	Temperature coefficient (ppm/°C)	Voltage coefficient (ppm/V)	Accuracy for full voltage
1 k	50	20 ppm	3	-	same
10 k	150	20 ppm	3	-	same
100 k	500	20 ppm	3	-	same
1 M	1250	20 ppm	5	-	same
10 M	5000	50 ppm	50	0.2	120 ppm
100 M	5000	300 ppm	50	1.2	0.7%
1 G	5000	0.5%	50	1.2	0.7%
10 G	5000	0.5%	50	2	1%
100 G	5000	1%	200	5	3%
1 T	5000	2%*	300	5	5%
10 T	5000	5%*	300	5	10%

* 1 TΩ and 10 TΩ calibrated at 1000 V

Dimensions: 43.2 cm W x 14.2 cm H x 13.5 cm D (17" x 5.6" x 5.3").

Weight: 3.6 kg (8 lb).

SI traceable

ORDERING INFORMATION

- VRS-100-9-1K-BP 9 Values, 1 kΩ to 100 GΩ Substituter, with binding posts 10 TΩ values may be included in any model - optional
 VRS-100-10-1K-BP 10 Values, 1 kΩ to 1 TΩ Substituter, with binding posts Optional combinations are available
 VRS-100-9-1K-ROT9 Values, 1 kΩ to 100 GΩ Substituter, with rotary switch
 VRS-100-10-1K-ROT 10 Values, 1 kΩ to 1 TΩ Substituter, with rotary switch



IET LABS, INC. in the **GenRad** Tradition
 534 Main Street, Westbury, NY 11590

www.ietlabs.com
 TEL: (516) 334-5959 • (800) 899-8438 • FAX: (516) 334-5988

RTD Series

- 50 ppm absolute accuracy
- 1 mΩ resolution
- No "zero" resistance; direct setting
- Highest performance RTD simulator available
- Highest accuracy, highest stability, lowest TC
- wide range - 10 Ω to 1111.110 Ω
- Virtually independent of contact resistance variation
- Ideal for DIN PT-100, PT-100 ANSI, PT-50 and NI-120 systems



Model RTD-Z-6-.001 High Accuracy RTD Simulator

RTD-Z RTD-X Series

High performance, low temperature coefficient, high stability, RTD simulator.

The RTD Series is ideal where applications of Resistance Temperature Detector (RTD) simulation require exact low value resistance without "zero" and contact resistance effects. The RTD-Z-6-.001 exhibits a resistance range of 10 Ω to 1,111.110 Ω, 1 mΩ lowest decade resolution, 50 ppm absolute accuracy. The RTD-Z-6-.01 has a 10 mΩ resolution.

If this simulator is substituted for any RTD, the rest of the system may be calibrated or examined. Special designs virtually eliminate zero resistance and switch contact variations, providing the specified absolute accuracy over the entire range.

RTD-250 Series

Economical accurate compact RTD simulator. New high stability design

The RTD-250 is a more economical version for less exacting requirements. The RTD-250 exhibits a resistance range of 20 Ω to 1,121.110 Ω, 1 mΩ lowest decade resolution, 50 ppm absolute accuracy.

Improved specifications

New!

Model		RTD-Z-6-.001	RTD-X-6-.001	RTD-Z-6-.01	RTD-X-6-.01	RTD-250
Specifications						
Minimum resistance (Ω)		10.000	10.000	10.00	10.00	20.00
Maximum resistance (Ω)		1,111.110	1,111.110	11,111.10	11,111.10	1,121.10
Resolution (mΩ)	1	1	10	10	10	
Number of decades	6	6	6	6	5	
Absolute accuracy (ppm)		50	100	50	100	200
Tempco max. (ppm/°C)		5	5	5	5	5
Tempco typical (ppm/°C)		3	3	3	3	3
Stability (ppm/24hrs)		2	2	2	2	2
Stability (ppm/year)	10	10	10	10	10	
Dimensions	W cm (in)	43.9(17.3)	43.9(17.3)	43.9(17.3)	43.9(17.3)	30.9(12.2)
	H cm (in)	8.9(3.5)	8.9(3.5)	8.9(3.5)	8.9(3.5)	8.9(3.5)
	D cm (in)	10.2(4)	10.2(4)	10.2(4)	10.2(4)	10.2(4)

* Absolute accuracy is independent of "zero" and contact resistance

Maximum power for rated accuracy:

100 mW or 100 mA for 10.000 to 10.999 Ω;

100 mW per step for the highest decade in use for 11 Ω and over.

Maximum current: 200 mA.

Breakdown voltage: 1000 Vrms

Operating Temperature: -55 to +75 °C

Switch life, typical: >100,000 operations

For programmable versions, see IET's PRTD Series, p. 23.



ORDERING INFORMATION

RTD-Z-6-.001	High Accuracy RTD Simulator, 1,111 Ω, 1 mΩ resolution, 50 ppm accuracy	RTD-X-6-.01	High Accuracy RTD Simulator, 11,111 Ω, 10 mΩ resolution, 100 ppm accuracy
RTD-X-6-.001	High Accuracy RTD Simulator, 1,111 Ω, 1mΩ resolution, 100 ppm accuracy	RTD-250	RTD Simulator, 1,121 Ω, 10 mΩ resolution, 0.02% accuracy
RTD-Z-6-.01	High Accuracy RTD Simulator, 11,111 Ω, 10 mΩ resolution, 50 ppm accuracy		



Standard Capacitance Reference or Working Standards

SC Series

High-stability, cost-effective capacitance standards with low temperature coefficient, low losses and a wide range of values.

- Wide range of values - 1 pF to 2000 μ F
- Mechanically stabilized capacitors
- <100 ppm/yr stability
- Excellent TC - as low as 10 ppm/ $^{\circ}$ C
- Low loss - D as low as 0.0002



SCA SERIES

Model SCA-	Adjustment to Nominal	TC (ppm/ $^{\circ}$ C)	Calibration Accuracy (%)	Test Conditions			Dissipation Factor (typical)	Maximum Voltage* (V)
				Frequency	Capacitor Model	No. of Termi- nals		
1 pF	± 0.1 pF	20	.01	1 kHz	Series	3	.002	500
1.9 pF	± 0.1 pF	20	.01	1 kHz	Series	3	.002	500
10 pF	± 0.1 pF	20	10 ppm	1 kHz	Series	3	.002	500
19 pF	± 0.1 pF	20	.01	1 kHz	Series	3	.001	500
100 pF	± 0.1 pF	20	10 ppm	1 kHz	Series	3	.0005	500
190 pF	± 0.1 pF	20	.01	1 kHz	Series	3	.0005	500
1 nF	$\pm 0.02\%$	20	10 ppm	1 kHz	Series	3	.0003	500
1.9 nF	$\pm 0.02\%$	20	.01	1 kHz	Series	3	.0003	500
10 nF	$\pm 0.02\%$	20	.01	1 kHz	Series	3	.0003	500
19 nF	$\pm 0.02\%$	20	.01	1 kHz	Series	3	.0003	500
100 nF	$\pm 0.02\%$	20	.01	1 kHz	Series	3	.0003	500
190 nF	$\pm 0.02\%$	20	.01	1 kHz	Series	3	.0003	500
1 μ F	$\pm 0.02\%$	20	.01	1 kHz	Series	5	.0002	500
1.9 μ F	$\pm 0.02\%$	20	.01	1 kHz	Series	5	.0002	100
5 μ F	$\pm 0.02\%$	-50	.012	1 kHz	Series	5	.0005	100
10 μ F	$\pm 0.04\%$	-50	.04	100 Hz	Series	5	.0005	44 Vrms†
19 μ F	$\pm 0.04\%$	-50	.04	100 Hz	Series	5	.0005	22 Vrms†
100 μ F	$\pm 0.05\%$	-50	.04	100 Hz	Series	5	.001	22 Vrms†
190 μ F	$\pm 0.05\%$	-50	.04	100 Hz	Series	5	.001	22 Vrms†
1000 μ F	$\pm 0.4\%$	-150	.15	100 Hz	Series	5	.001	22 Vrms†

* Peak up to 10 kHz.

† Maximum allowable Vrms; subject to maximum Vdc = 50 V and max Vrms = (39000/f) for C = 10 μ F; (26000/f) for C = 19 μ F; (13000/f) for C \geq 100 μ F, where f = frequency (in Hz).

Terminals: Two BNC connectors for 190 pF and under; two 5-way binding posts for 1 nF to 190 nF; four 5-way binding posts for 1 μ F and over. Case ground is also provided.

Stability: <(0.01% + 0.1 pF) per year, up to 1 μ F.

Dimensions: 8.6 cm H x 10.5 cm W x 12.7 cm D (3.4" x 4.15" x 5"); for 1000 μ F: 8.6 cm H x 30.5 cm W x 8.92 cm D (3.4" x 12" x 3.5").

Transit Case: Optional Model SRC-100 lightweight transit case with handle, suitable for transporting and storing two units. The case provides insulation from temperature changes during transportation or shipping.

Calibration Report: SI traceable initial calibration data provided with unit.

Capacitor Type: Air capacitors for 1 pF and 10 pF; hermetically sealed silvered mica for 100 pF to 100 nF; hermetically sealed polystyrene for 10 μ F; hermetically sealed metalized polycarbonate for 10 μ F steps and over.

Operating Temperature: 10 $^{\circ}$ C to 50 $^{\circ}$ C.

ORDERING INFORMATION

SCA-Value
SRC-100

Standard Capacitor
Lightweight transit case with handle;
See p. 27

Other values of
capacitance and calibration
frequencies available.

- Optional combinations



IET LABS, INC. in the **GenRad** Tradition
534 Main Street, Westbury, NY 11590

www.ietlabs.com
TEL: (516) 334-5959 • (800) 899-8438 • FAX: (516) 334-5988

SRR • Series

SRR SERIES

Reichsanalt type four-terminal standard resistors for low values of 0.1 or less. These stan-

dards are used for accurate current measurements and for comparisons of low resistances.

Model	Nominal Value (Ω)	Adjustment to Nominal Value	Calibration Accuracy (±ppm)	Dissipation (W)		Temperature Coefficient (ppm/C)
				Air	Oil	
SRR-.0001	0.000 1	.02%	6 to 8	1	4	20
SRR-.001	0.001	100 ppm	1.5 to 8	1	4	25
SRR-.01	0.01	100 ppm	1 to 6	1	4	5
SRR-0.1	0.1	30 ppm	1 to 2	1	4	5

* When immersed in an oil bath.

Calibration Report: Initial calibration data provided at 25°C, NIST certificate will be furnished upon request for a nominal charge.

Weight: 1 kg (2.25 lb).

Dimensions: 18 cm across contact arms with 8 cm diameter and 18 cm height for model SRR-0.1; 18 cm across contact arms with 8 cm diameter and 12 cm height for models SRR-.001 and SRR-0.1.



0.1 Reichsanalt Standard

HATS-LR Series

Make accurate calibrations and transfer measurements over three decades of resistance with the HATS-LR Series.

- Steps from 1 Ω to 100 kΩ
- Transfers from 0.1 Ω to 1 MΩ
- High transfer accuracy - to 1 ppm

The Benefits of Using Transfer Standards

In order to perform calibrations with a high degree of accuracy, reference standards must be employed at every range or decade of the measuring or calibration instrumentation. Clearly, this can be difficult and costly since these standards must be highly stable and their precise values must be known with a high degree of certainty and sufficient resolution. To minimize the cost and difficulty, more practical means of performing such calibrations is to use transfer standards.

If one has a single standard that is calibrated by a national laboratory, one can then compare the transfer standards to the certified standard by ratio techniques. [See p. 5 for a full tutorial.](#)

SPECIFICATIONS

Resistor Type: Wirewound, hermetically sealed, low inductance.

Step Size: 1 Ω, 10 Ω, 100 Ω, 1 kΩ, 10 kΩ, or 100 kΩ.

Accuracy:

Initial: ± 15 ppm for 1 Ω, 10 Ω steps;
± 10 ppm for 100 Ω through 100 kΩ steps.
Long Term: ± 10 ppm/year;

Transfer: $\pm(1 \text{ ppm} + 0.1 \mu\Omega)$ for 10:1 and 100:1 ratios for 1 Ω, 100 Ω, 1 kΩ, 10 kΩ, and 100 kΩ steps;
 ± 1 ppm for 10:1 and 100:1 ratios for 10 Ω step.
(Transfer accuracies apply when HATS-LR-SB, HATS-LR-PC, or HATS-LR-SP fixtures are used)

Matching:

Accuracy: within 10 ppm for 1 Ω, 10 Ω steps;
within 5 ppm for 100 Ω through 100 kΩ steps.

Temperature Coefficient:

within 5 ppm/°C for 1 Ω step;
within 1 ppm/°C for $\geq 100 \Omega$ steps and for HATS-LRTC-10
within 2 ppm/°C for HATS-LR-10 only

Calibration Accuracy: <math>< 10</math> ppm for 1 Ω
<math>< 5</math> ppm for all others.

Functional Schematic:

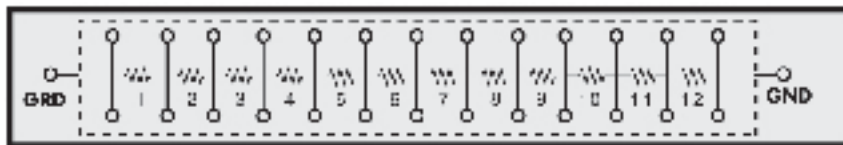

ORDERING INFORMATION

HATS-LR-1 1 Ω/step transfer standard
HATS-LR-10 10 Ω/step transfer standard
HATS-LRTC-10 10 Ω/step transfer standard with low temperature coefficient
HATS-LR-100 100 Ω/step transfer standard
HATS-LR-1K 1 kΩ/step transfer standard

HATS-LR-10K 10 kΩ/step Transfer Standard
HATS-LR-100K 100 kΩ/step Transfer Standard
HATS-LR-SB Shorting bars for HATS-LR units
HATS-LR-PC Parallel Compensation Network
HATS-LR-SP Series-Parallel Compensation Network
OPTIONS
- RM Rack mountable case for standard 19" rack



Model HATS-LR-10 Transfer Standard with HATS-LR-SB shorting bars

The HATS-LR Series of transfer standards consist of 12 matched resistors, of value R, which may be connected in series or parallel combinations to produce any number of values such as R/10, R, and 10R, all with the same known deviation, thereby allowing progressive transfers to higher and lower decades. For example, the 10 kΩ transfer standard may be used to transfer calibrations across 1 kΩ, 10 kΩ and 100 kΩ.

The HATS-Y Series (p. 3) of transfer standards may be used for resistances $\geq 1 \text{ M}\Omega$.

Temperature Coefficient:

± 1 ppm/°C for HATS-LRTC-10 (low TC version)
 ± 10 ppm/°C for HATS-LR-1;
 ± 3 ppm/°C for HATS-LR-10;
 ± 2 ppm/°C for HATS-LR-100 through 100K.

Power Coefficient:

± 0.1 ppm/mW per resistor for HATS-LR-1;
 ± 0.15 ppm/mW per resistor for HATS-LR-10;
 ± 0.02 ppm/mW per resistor for HATS-LRTC-10;
 ± 0.05 ppm/mW per resistor for HATS-LR-100 through 100K.

Maximum Applied Input: 1500 V maximum or 1 W per resistor, or 5 W for entire unit, whichever applies. 1500 V peak between any terminal and case.

Dimensions: 31.2 cm W x 9.7 cm H x 11.4 cm D (12.3" x 3.8" x 4.5").

Weight: 2 kg (4.4 lb).

Calibration Conditions: Four-wire Kelvin measurements, low power, at 23°C, traceable to NIST. Initial calibration data supplied with instrument.

Leakage Resistance: Greater than 1 TΩ from terminal to case.

Shorting Bars and Compensation Networks: For connecting resistors in parallel or series-parallel combinations.



HATS-Y Series

Make accurate calibrations and transfer measurements over three decades of resistance with the HATS-Y Series.

- Steps from 1 MΩ to 100 MΩ
- Transfers from 0.1 MΩ to 100 MΩ
- 11 precisely matched resistors
- High transfer accuracy - better than 2 ppm

The Benefits of Using Transfer Standards

In order to perform calibrations with a high degree of accuracy, reference standards must be employed at every range or decade of the measuring or calibration instrumentation. Clearly, this can be difficult and costly since these standards must be highly stable and their precise values must be known with a high degree of certainty and sufficient resolution. To minimize the cost and difficulty, more practical means of performing such calibrations would be to use transfer standards.

If one has a single standard that is calibrated by a national laboratory, one can then compare the transfer standards to the certified standard by ratio techniques. See p. 5 for a full tutorial.



10 MΩ HATS-Y Transfer Standard

The HATS-Y Series of transfer standards consist of 11 matched resistors, of value R, which may be connected in series or parallel combinations to produce any number of values such as R/10, R, and 10R, all with the same known deviation, thereby allowing progressive transfers to higher and lower decades. For example, the 1 MΩ transfer standard may be used to transfer calibrations across 100 kΩ, 1 MΩ and 10 MΩ.

The HATS-LR Series (p. 33) of transfer standards may be used for resistances 100 kΩ and under.

These transfer standards may also be employed as very precise and stable voltage dividers.

SPECIFICATIONS

Step Size	100 kΩ	1 MΩ	10 MΩ	100 MΩ
Adjustment Accuracy	±10 ppm	±20 ppm	±20 ppm	±100
Transfer Accuracy	±2 ppm	±2 ppm	±2 ppm	±30 ppm
Stability ppm/year	±10 ppm	±15 ppm	±20 ppm	±30 ppm
Stability long term	±30 ppm	±30 ppm	±30 ppm	±50 ppm
Temperature Coefficient	±1 ppm/°C	±3 ppm/°C	±5 ppm/°C	±5 ppm/°C
Matching				
Adj. Acc.	±10 ppm	±10 ppm	±10 ppm	±20 ppm
TC	±1 ppm	±3 ppm	±3 ppm	±5 ppm
Calibration Uncertainty	±5 ppm	±10 ppm	±10 ppm	±15 ppm

Calibration Conditions: 23°C, with meter guard applied to COM and ground applied to G, at low power, traceable to SI. Initial calibration data supplied with instrument.

Leakage Resistance: >10 TΩ from terminal to case.

Power Coefficient: <±0.05 ppm/mW per resistor.

Maximum Applied Input: 2500 V, or 1 W per resistor, or 10 W for entire unit, whichever limit applies first. 3500 V peak, between any terminal and case.

Operation: (Switch 0 is left most switch). To set standard to R/10, set Switch 0 down, Switch 1 up, switch 2 down and so on; Switch 11 off.

To set standard to 10R, set Switch 0 down, Switch 10 up, all other switches off.

To set standard to 1R, set Switches 0 and 6 down, Switches 3 and 9 up, all other switches off.

Dimensions: 35.6 cm W x 16.5 cm H x 10.2 cm D (14" x 6.5" x 4").

Weight: 5 kg (11 lb.).

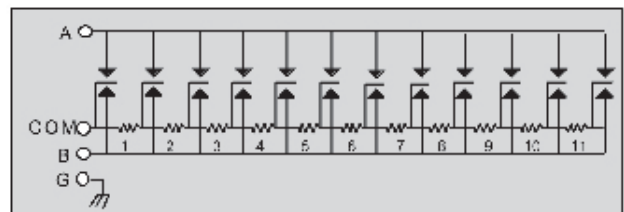

ORDERING INFORMATION

HATS-Y-100K	100 kΩ/Step Transfer Standard
HATS-Y-1M	1 MΩ/Step Transfer Standard
HATS-Y-10M	10 MΩ/Step Transfer Standard
HATS-Y-10M	10 MΩ/Step Transfer Standard

OPTIONS

- RM Rack mountable case for standard 19" rack



Digital Potentiometer Kelvin-Varley Voltage Divider

KVD-500 Series

DP-500 Series

- Digital potentiometers and Kelvin-Varley voltage dividers
 - Suitable for use in voltage and current dividers
 - Eliminates the need for dials & multi-turn potentiometers
 - 1, 2, 3, 4, 5, and 6 decade units are available

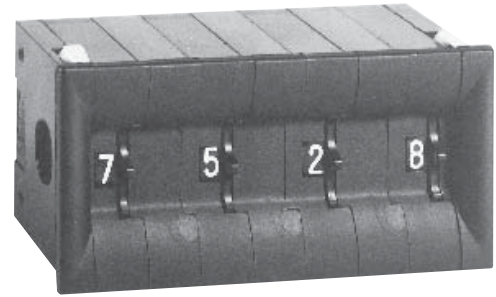

4 Decade DP-500 Digital Potentiometer or
KVD-500 Voltage Divider (HVD-500 not shown)

SELECTION GUIDE

KVD-500 Series

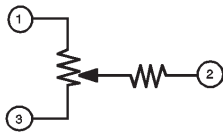

Kelvin-Varley Voltage divider circuit - more economical than the DP-500. Operates in the same way as the DP-500, except that it has an additional, but variable resistance in series with the wiper arm which goes to zero at the full scale and zero settings. Use this type where the wiper is input into a high input impedance or if it does not affect the particular application; The KVD-500 is suitable for most voltage divider applications. See KVD-600/KVD-700 (p. 29) for additional information.

DP-500 Series

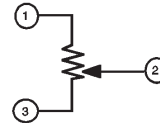

TRUE potentiometer circuit. Use this type where needed to substitute for a three terminal potentiometer, where all three terminals are required individually.

RS Series

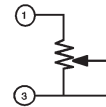

Two terminal variable digital resistance - most economical whenever three terminals are not required. See RS Series data sheet (p. 9) for additional information.

SPECIFICATIONS

KVD-500 and DP-500

- Minimum Potentiometer Resistance: 0.05 Ω/decade.
- Power Across Input Terminals: 2 W; others available.
- Temperature Coefficient: 50 ppm/°C; others available.
- Operating Temperature: 10°C to 50°C.

ORDERING INFORMATION

IET can supply any value in a number of tolerances and decades. A part number is determined as follows:

KVD-500 - B - 50k - 5 - PM (Example: 50 kΩ, 0.1%, 5 decade Kelvin-Varley Divider for panel mounting)

SERIES	TOLERANCE	TOTAL* RESISTANCE(Ω)	NO. OF DECADES**						OPTIONS
KVD-500 DP-500	X: 0.01% ± 5 mΩ Q: 0.02% ± 5 mΩ A: 0.05% ± 50 mΩ B: 0.1% ± 50 mΩ C: 0.5% ± 50 mΩ E: 1.0% ± 50 mΩ		1	2	3	4	5	6	PM: Supplied without case for panel mounting or other use WC: Packaged in a plastic case with binding posts. Size: 81 mm x 79 mm x 56 mm (3.2 x 3.1 x 2.2 in.) or 120 mm x 79 mm x 56 mm (4.7 x 3.1 x 2.2 in.) xV: Maximum voltage for HVD-500
		1, 2, 5	x						
		10, 20, 50	x	x					
		100, 200, 500	x	x					
		1 k, 2 k, 5 k	x	x	x	x			
		10 k, 20 k, 50 k	x	x	x	x	x		
		100k, 200k, 500k	x	x	x	x	x	x	
		1 M, 2 M, 5 M	x	x	x	x	x	x	
		10 M, 20 M, 50 M	x	x	x	x	x	x	

* For HVD-500, resistance range is 1 MΩ - 1 TΩ
Other resistance values available on request.
** Number of decades for KVD-500 and DP-500.

Decimal points available on request



KVD-600 • KVD-700 • Series

These standards grade Kelvin-Varley voltage dividers are highly accurate, stable, and linear instruments for use in many applications requiring accurately known voltage or current ratios. In particular, the KVD series is especially

appropriate for use in bridge circuits, providing two arms of a bridge with a very well known ratio. Applications include linearity determination, the measurement of voltage and resistance, and the calibration of voltage, current, and resistance.

SPECIFICATIONS

KVD-600



KVD-700

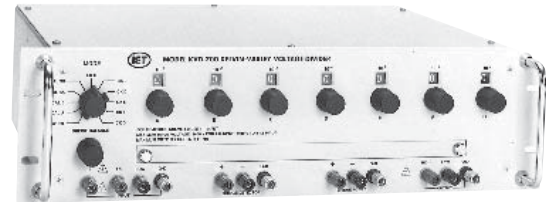

Equivalent circuit: A Kelvin-Varley voltage divider may be thought of as being equivalent to a digital potentiometer. However, it has an additional, but variable, resistance in series with the wiper arm, which goes

to zero at the full scale and zero settings. This series resistance has no effect in balanced bridge type applications, where these dividers are often used.

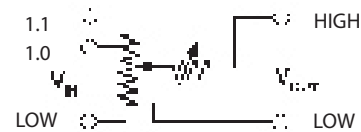
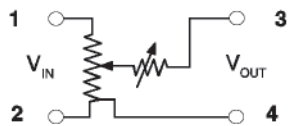

Series	KVD-600	KVD-700
Calibration:	Requires external calibration.	Self calibrating; has internal oil bath.
Ratio Range:	0 to 1.0 of input.	0 to 1.0 input for 1.0 terminal; 0 to 1.1 of input for 1.1 terminal.
Resolution:	0.1 ppm with 7 decades.	0.1 ppm with 7 decades.
Absolute Linearity: $[V_{out}/V_{in}] - S$ where S is the dial setting.	±0.5 ppm	±0.1 ppm for S = 0.1 to 1.1; ±0.1(10S) ^{1/3} ppm for S = 0 to 0.1.
Short-Term Linearity Stability:	0.2 ppm/30 days under standard laboratory conditions and $V_{IN} < 100$ V.	0.1 ppm/30 days under standard laboratory conditions and $V_{IN} < 100$ V.
Long-Term Linearity Stability:	±2.0 ppm of input/year.	±1.0 ppm of input/year for S=0.1 to 1.1; ±(10S) ^{2/3} ppm of input/year for S=0 to 0.1; Self calibration restores linearity to 0.1 ppm.
Temperature Coefficient of Linearity:	<±0.2 ppm/°C.	<±0.1 ppm/°C for S=0.1 to 1.1; <±0.1 (10S) ^{2/3} ppm/°C for S=0 to 0.1.
Power Coefficient of Linearity:	±1 ppm/watt.	<±0.2 ppm of input/W for S=1.1 to 0.1; <±0.2 (10S) ² ppm of input/W for S=0.1 to 0.
Maximum Input Power:	2.5 watts; 5 watts intermittent.	10 W at 1.0 INPUT; 11 W at 1.1 INPUT.
Maximum Input Voltage:	1000 V	1000 V at 1.0 input terminal; 1100 V at 1.1 input terminal;
Input Resistance:	100 kΩ ±50 ppm.	100 kΩ ±50 ppm at 1.0 INPUT; 110 kΩ ±50 ppm at 1.1 INPUT.
Maximum Output Resistance:	66 kΩ, determined by shorting across the input and measuring the resistance across the output terminals.	
Terminals:	High quality low thermal emf gold plated tellurium copper binding posts.	
Dimensions:	48.3 cm W x 13.3 cm H x 18.5 cm D (19.0" x 5.25" x 7.3").	5.25" high rack panel; 13.3 H x 48.2 W x 33.0 D (5.25" x 19.0" x 13.0").
Weight:	4.1 kg (9 lb).	8.2 kg (18 lb).



HACS Series

Please see the Genrad 1423-A Precision Decade
Capacitor
Consult IET



HACS-Z Series

p. 1 of 2

The HACS-Z provides a wide range of capacitance in increments as low as 1 pF and a total capacitance of up to 10,000 μF . With its high

- High accuracy: 0.05% or 0.1%
- Low zero capacitance <0.1 pF
- Programmable version available
- Trimmable capacitors for lower decades
- 3-Terminal shielded construction
- Excellent stability - 100 ppm/yr
- Special high voltage units up to 10 kV
- Excellent TC - begins at 20 ppm/ $^{\circ}\text{C}$

SPECIFICATIONS

Capacitor Type: Air capacitors for 1 and 10 pF steps; stabilized sealed silvered-mica for 100 pF through 100 nF steps; hermetically sealed polystyrene capacitors for 1 μF steps; hermetically sealed metallized polycarbonate capacitors for 10 μF steps and over; polypropylene for 1000 μF steps. 1, 10, 100 and 1000 pF decades are trimmable from rear.

Accuracy:

A: $\pm(0.05\% + 0.5 \text{ pF})$; $\pm 0.5\%$ for 100 μF steps.

B: $\pm(0.1\% + 1.0 \text{ pF})$; $\pm 0.5\%$ for 100 μF steps.

[If 1,000 μF steps are present, accuracy for 6 to 10 μF at 1 kHz is $\pm(0.1\% + 0.5 \text{ pF})$]

Test Conditions:

at 1 kHz for 1 pF to 10 μF ; 100 Hz for 1 μF and over, at 23 $^{\circ}\text{C}$, no zero subtraction, measured with a 3-terminal connection. (Calibration at other frequencies is available, and different frequencies may be selected for different decades.) SI traceable.

Range: 0 to 10,000 μF available, with minimum increments of 1 pF; see table on next page.

Dissipation Factor:

<0.002 for 1 pF and 10 pF steps;
<0.001 for 100 pF steps;
<0.0005 for 1 nF and 2 nF steps;
<0.0003 for 3 nF step through all 0.01 μF steps;
<0.0004 for 0.1 μF steps;
<0.0007 for 1 μF steps;
<0.007 for 10 μF steps;
<0.005 for 100 μF steps.

Zero Capacitance:

$\leq 0.1 \text{ pF}$, measured with a 3-terminal connection, for units with highest decade steps $\leq 100 \text{ nF}$;
 $\leq 2 \text{ pF}$, measured with a 3-terminal connection, for units with highest decade steps 1 μF .

DOUBLE SHIELDED CONSTRUCTION

The shielding is divided into two different parts: an inner shield that minimizes the low terminal-to-guard capacitance, and an outer shield (the case) that minimizes the detector input capacitance and noise.

When these two shields are connected together, the HACS-Z becomes an excellent 3-terminal capacitance substituter with low zero capacitance.

quality, tight tolerance capacitors, it is an ideal part of a test or calibration system.



Six Decade HACS-Z Capacitance Substituter

Insulation Resistance: >50,000 M Ω .

Operating Frequency Range: 10 Hz or less to at least 1 MHz.

Stability:

A: $\pm(100 \text{ ppm} + 0.1 \text{ pF})$ per year for 0.1 μF steps and under;
 $\pm 200 \text{ ppm}$ per year for 1 μF and 10 μF steps;
 $\pm 500 \text{ ppm}$ per year for 100 μF and 1000 μF steps.

B: $\pm(200 \text{ ppm} + 0.1 \text{ pF})$ per year for all steps.
 $\pm 500 \text{ ppm}$ per year for 1 μF and 10 μF steps;
 $\pm 1000 \text{ ppm}$ per year for 100 μF and 1000 μF steps.

MAXIMUM VOLTAGE:

1 pF through 100 nF steps: 500 V peak max up to 10 kHz;

1 μF steps: 50 V peak max

10 μF and 100 μF steps: $(V_{dc} + V_{ac}) < 30 \text{ V}$ or $(V_{ac}) < 22 \text{ V}$, whichever applies first, where $V_{ac} = 1.8 \times 10^4 / f$, and f is freq. in Hz

Optional: up to 10 kV

Temperature Coefficient:

A: $\approx 20 \text{ ppm}/^{\circ}\text{C}$ for 0.1 μF steps and under;
 $-50 \text{ ppm}/^{\circ}\text{C}$ for 1 μF through 100 μF steps;
 $-150 \text{ ppm}/^{\circ}\text{C}$ for 1000 μF steps;

Operating Temperature Range: 10 $^{\circ}\text{C}$ to 40 $^{\circ}\text{C}$.

Operating Frequency Range: 10 Hz or less to at least 1 MHz.

Shielding: Double shielded construction.

Dimensions: 43.2 cm W x 14.2 cm H x 30.4 cm D (17" x 5.6" x 12"), for 6 decade version.

Weight: 5.9 kg (13 lb), for 6 decade version.

Connection to Substituter: BNC (standard) or 874 type coaxial connectors (optional) labeled HI and LO on front panel. Also available is an optional 36 pin connector providing individual BCD weighted equivalent contacts for each decade.

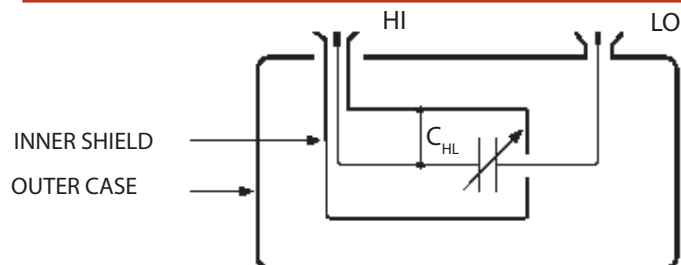

Double Shielded Construction



HACS-Z Series

p. 2 of 2

ORDERING INFORMATION

STANDARD MODELS

Models*		Total Capacitance	No. of Decades	Resolution
Accuracy 0.05%	Accuracy 0.1%			
HACS-Z-A-3E-1pF	HACS-Z-B-3E-1pF	1,110 pF	3	1 pF
HACS-Z-A-3E-10pF	HACS-Z-B-3E-10pF	11,100 pF	3	10 pF
HACS-Z-A-3E-100pF	HACS-Z-B-3E-100pF	111,000 pF	3	100 pF
HACS-Z-A-3E-1nF	HACS-Z-B-3E-1nF	1.11 μF	3	1 nF
HACS-Z-A-3E-10nF	HACS-Z-B-3E-10nF	11.1 μF	3	10 nF
HACS-Z-A-3E-100nF	HACS-Z-B-3E-100nF	111 μF	3	100 nF
HACS-Z-A-3E-1μF	HACS-Z-B-3E-1μF	1,110 μF	3	1 μF
HACS-Z-A-3E-10μF	HACS-Z-B-3E-10μF	11,100 μF	3	10 μF
HACS-Z-A-4E-1pF	HACS-Z-B-4E-1pF	11,110 pF	4	1 pF
HACS-Z-A-4E-10pF	HACS-Z-B-4E-10pF	0.1111 μF	4	10 pF
HACS-Z-A-4E-100pF	HACS-Z-B-4E-100pF	1.111 μF	4	100 pF
HACS-Z-A-4E-1nF	HACS-Z-B-4E-1nF	11.11 μF	4	1 nF
HACS-Z-A-4E-10nF	HACS-Z-B-4E-10nF	111.1 μF	4	10 nF
HACS-Z-A-4E-100nF	HACS-Z-B-4E-100nF	1,111. μF	4	100 nF
HACS-Z-A-4E-1μF	HACS-Z-B-4E-1μF	11,110 μF	4	1 μF
HACS-Z-A-5E-1pF	HACS-Z-B-5E-1pF	0.111 11 μF	5	1 pF
HACS-Z-A-5E-10pF	HACS-Z-B-5E-10pF	1.111 1 μF	5	10 pF
HACS-Z-A-5E-100pF	HACS-Z-B-5E-100pF	11.111 μF	5	100 pF
HACS-Z-A-5E-1nF	HACS-Z-B-5E-1nF	111.11 μF	5	1 nF
HACS-Z-A-5E-10nF	HACS-Z-B-5E-10nF	1,111.1 μF	5	10 nF
HACS-Z-A-5E-100nF	HACS-Z-B-5E-100nF	11,111 μF	5	100 nF
HACS-Z-A-6E-1pF	HACS-Z-B-6E-1pF	1.111 11 μF	6	1 pF
HACS-Z-A-6E-10pF	HACS-Z-B-6E-10pF	11.111 1 μF	6	10 pF
HACS-Z-A-6E-100pF	HACS-Z-B-6E-100pF	111.111 μF	6	100 pF
HACS-Z-A-6E-1nF	HACS-Z-B-6E-1nF	1,111.11 μF	6	1 nF
HACS-Z-A-6E-10nF	HACS-Z-B-6E-10nF	11,111.1 μF	6	10 nF
HACS-Z-A-7E-1pF	HACS-Z-B-7E-1pF	11,111.11 μF	7	1 pF

*For 10 position switches, "0" - "9", in lieu of 11 position "0" - "10", delete E from model number.
Add suffix: BCD- for the BCD output option, RM- for rack mount option.

OPTIONAL MODELS

In order to satisfy any requirement for a HACS-Z Series capacitor, generate a part number from the chart below.

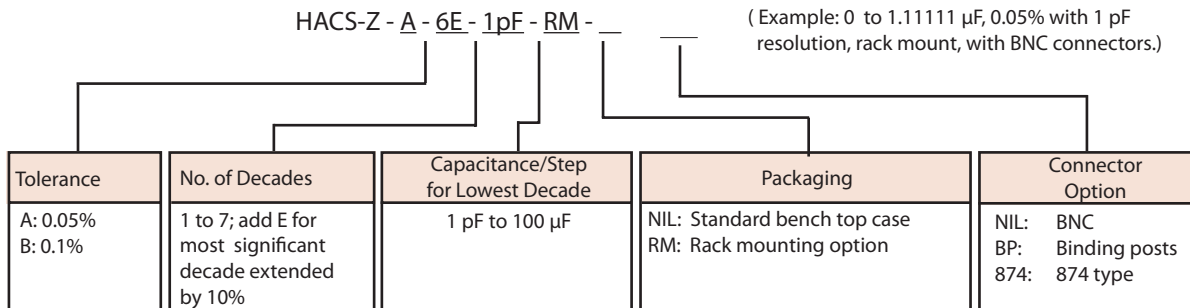

SC-900 Series

Please see the Genrad 1422 Precision
Capacitor Series

p. 66



VI-700 Series

Various features and options make the VI -700 an effective choice for many manual and programmable voltage and current applications.

- Voltage output range of 100 μ V to 20 V or 200 V
- Current output range of 0.1 μ A to 20 mA or 200 mA
- 3½ digit resolution, 0.75 LSD accuracy
- Manual thumbwheel operation or programmable digital input, IEEE-488 or parallel BCD interface.
- Optional portable power pack
- May be used as a component in a closed loop control system

Improved specifications



Model VI-700 Precision Voltage and Current Source

SPECIFICATIONS

Voltage	
Output Ranges	200 mV, 2 V, 20 V; (200 V with HV option).
Resolution	100 μ V, 1 mV, 10 mV; (100 mV with HV option).
Accuracy	\pm (75 ppm + 50 μ V); 200 mV range; \pm (75 ppm + 0.25 mV), 2 V range; \pm (75 ppm + 2.5 mV), 20 V range; at 23°C, no load, after warmup.
Output Current	70 mA, (200 mA with HP option) maximum load up to 20 V; (10 mA for 200 V range with HV option); with LED overload indicator.
Output Impedance	5 m Ω typical, 40 m Ω for 20 V range.
Noise and Ripple	50 μ Vrms on 200 mV and 2 V ranges; 50 μ Vrms on 200 mV and 2 V ranges; 100 μ Vrms on 20 V range.
Tempco	\pm 10 ppm/°C typical; \pm 15 ppm/°C max.

Current	
Output Ranges	200 μ A, 2 mA, 20 mA, 200 mA (with HI option).
Resolution	0.1 μ A, 1 μ A, 10 μ A; 100 μ A (with HI option).
Accuracy \pm (75 ppm)	+ .05 μ A); 200 μ A; \pm (75 ppm + 0.25 μ A), 2 mA; \pm (75 ppm + 2.5 μ A), 20 mA; 23°C, no load.
Compliance Voltage	0-20 V; with LED overload indicator.
Noise	8-20 nA.

General	
Digital Input	3½ digit parallel BCD or IEEE-488 interface; a front panel push-button selects REMOTE or LOCAL operation.
Isolation	Floating outputs, optically isolated from digital inputs; voltage and current out- puts may be used in either polarity.
Power Requirements	105-125 V or 210-250 V; 50-60 Hz; 5 W.
Dimensions	21.6 cm W x 12.6 cm H x 22.9 cm D (8.5" x 2.8" x 9.0") for Standard Model; 21.6 cm W x 8.7 cm H x 23.5 cm (8.5" x 3.44" x 9.25") for IEEE-488 interface option.
Weight	2.3 kg (5 lb).

Operating Temperature Range: 10°C to 40°C.
Storage Temperature Range: -40°C to 60°C.

ORDERING INFORMATION

Model VI-700-110	Precision Voltage & Current Source; 110 Vac op.
Model VI-700-220	Precision Voltage & Current Source; 220 Vac op.
-HP Option	High power output, up to 200 mA output
-HI Option	200 mA output (in addition to 200 μ A-20 mA)
-HV Option	200 V output (in addition to 100 μ V -10 mV)
-RS Option	Remote sensing directly to load
-BCD Option	Parallel BCD Remote Programming
-IEEE Option	IEEE-488 Remote Programming
IEEE-488	Interface hardware (see p. 48)
IEEE-488	Interface software (see pp. 46-47, 49)
BP-511	Battery Pack, AC source, 115 V, 60 Hz, 300 W (see p. 48)



HSVR Series

The HSVR Series is a highly stable compact voltage reference with a very low temperature coefficient. It is suitable for printed

circuit board mounting and whenever precision voltages are required for test, calibration, digital and analog conversions, etc...

- Replacement for Eppley and other standard cells
- High stability - up to 25 ppm/year (better available)
- Short circuit output protection
- Trimmable outputs
- Small size - PC board mounting
- Excellent temperature coefficient - 1 ppm/°C

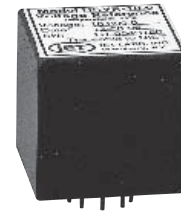

One inch cube High Stability Model HSVR Voltage Reference

SPECIFICATIONS

Model Description:

Model	Input Voltage ± 1 V	Output Voltage*	Max. Output Current
HSVR-1.01	12 V	1.01 V	1 mA
HSVR-6.3	22 V	6.3 V	1 mA
HSVR-12.6	24 V	12.6 V	1 mA
HSVR-18.0	30 V	18.000 V	1 mA
HSVR-18.9	30 V	18.9 V	1 mA

* Other values available may be specified as a cell replacement.

Output Voltage Stability:

1 ppm per 24 hours;
10 ppm per month;
25 ppm per year.

Calibration Accuracy: <2 ppm

Temperature Coefficient:

<1 ppm/°C typical for temperature range of 0° to 50°C.

Operating Temperature: 0°C to 50°C.

Input Voltage: Operating range of ± 3 V.

Input Voltage Regulation: Within 1 ppm of output voltage for a 10% change of input voltage.

Settling Time:

To within 1 ppm of final value after 10 minutes;
To within 10 ppm of final value after turn on.

Input Power: 0.5 W, nominal.

Dimensions: 2.54 cm W x 2.54 cm H x 2.54 cm D (1" x 1" x 1").

PIN ASSIGNMENTS:

Bottom
View

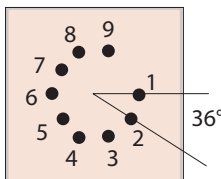

Diameter of pin circle: 0.468"
Pin diameter: 0.04"
Location of pin "1": 3:00
Pin Length: 0.25" \pm 0.05"

Pin No.	Function
1	Vout low
2	NC - no user connection
3	Vout high
4	NC - no user connection
5	NC - no user connection
6	NC - no user connection
7	Power supply low
8	NC - no user connection
9	Power supply high

ORDERING INFORMATION

HSVR-1.01 1.01 V High Stability Voltage Reference
HSVR-6.3 6.3 V High Stability Voltage Reference

HSVR-12.6 12.6 V High Stability Voltage Reference
HSVR-18.0 18.0 V High Stability Voltage Reference
HSVR-18.9 18.9 V High Stability Voltage Reference

The HSVR Series may be supplied in custom voltages or multiple output combinations.



IMF-600A Series

p. 1 of 2

Various output options and autoranging make the IMF-600 an attractive choice for many impedance measurement and process requirements.

CAPACITANCE • INDUCTANCE • RESISTANCE

- C-L-G-R
- Dissipation for capacitors
- 1/Q for inductors
- Analog, digital, or 4-20 mA outputs
- High accuracy
- Protected circuitry
- Very broad range
- Analog & digital outputs
- 4-wire shielded Kelvin test terminals
- Excellent for locating shorts
- Optional autoranging
- Optional portable ac power pack



Model IMF 600-A Impedance Meter

DESCRIPTION

A perfect bench companion to your DMM, the IMF-600A is a cost effective manual or autoranging digital impedance meter that complements the basic DMM to complete your test and measurement needs. With its low resistance measurement capacity and Kelvin leads, the IMF-600A is invaluable for locating PC board shorts.

A number of attractive features make it a versatile device. A companion limits comparator, Model LC-603, allows selection for all functions, on a GO/NO GO basis for inspection, sorting, quality control, component selection, etc...

Automatic measurement for all functions is provided automatically with a 3½ digit display. No balancing or manual operations are required.

Analog & digital outputs may be used to interface to comparators or other devices.

4-Wire shielded Kelvin test terminals - short circuit location ensures precision measure-

ments even for very low impedances like contact or wire resistance and makes locating PC board short circuits an easy task.

Principle of Operation

The impedance Z_x of an unknown component X is defined as:

$$Z_x = V_x / I_x$$

where V_x is the voltage across the unknown and I_x is the current through the unknown. The IMF-600A implements this computation

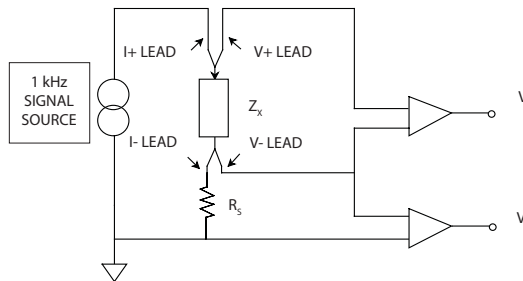

as shown conceptually in the figure. A sine wave generator drives current I_x through unknown Z_x and the standard resistor R_s in series with it. Two ac coupled differential amplifiers measure the voltages V_x and V_s across the unknown and the resistor respectively. The impedance Z_x is then computed as follows:

$$Z_x = V_x / I_x$$

$$Z_x = R_s V_x / V_s$$

Except for pure resistance and conductance, Z_x is a complex ratio with real and imaginary components which are then computed. The voltage being measured, e.g. V_x is broken down into the "in phase or 0°" and the "quadrature or 90°" components with respect to the test signal. These are used to provide the real and imaginary portions of the complex impedance. A pure resistance, for example, will produce only an "in phase" component, whereas an ideal capacitor will result in only a "quadrature" signal.

PROCESS CONTROL APPLICATIONS

Many industrial and manufacturing processes such as flow or fill procedures or many similar fabricating steps lend themselves to automatic control since the parameter to be controlled is often proportional to the capacitance.

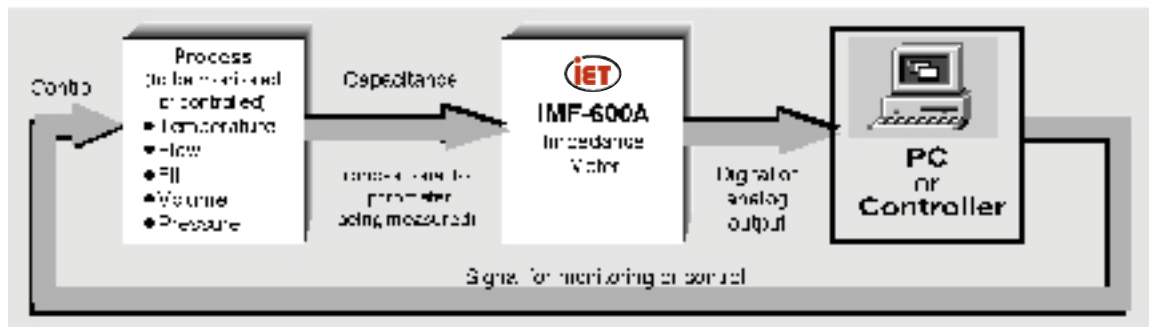

IMF-600A Series

p. 2 of 2

GENERAL SPECIFICATIONS

C - Range	1*	2	3	4	5	6	7	8
Full Scale	200 pF	2 nF	20 nF	200 nF	2 μF	20 μF	200 μF	2000 μF ¹
Resolution	0.1 pF	1 pF	10 pF	100 pF	1 nF	0.01 μF	0.1 μF	1 μF
Test Signal	1.0 Vrms		100 mVrms					10 mVrms
Accuracy ⁴	±(0.25% + 1 LSD + 0.5% G reading)	±(0.25% + 1 LSD + 0.5% Greading)					±(0.25% + 1 LSD + 0.2% Greading)	±(5% + 1 LSD + 1% G reading)
G - Range	1	2	3	4	5	6	7	8
Full Scale	2 μS	20 μS	200 μS	2 mS	20 mS	200 mS	2000 mS	20 S
Resolution	0.001 μS	0.01 μS	0.1 μS	1 μS	10 μS	0.1 mS	1 mS	10 mS
Test Signal	1.0 Vrms		100 mVrms					10 mVrms
Accuracy	±(0.25% + 1 LSD + 0.5% C reading)	±(0.25% + 1 LSD + 0.5% Creading)					±(0.25% + 1 LSD + 0.2% Creading)	±(5% + 1 LSD + 1% Creading)
L - Range	1**	2	3	4	5	6	7	8
Full scale	200 μH	2 mH	20 mH	200 mH	2 H	20 H	200 H	200 H
Resolution	0.1 μH	1 μH	10 μH	0.1 mH	1 mH	10 mH	0.1 H	0.1 H
Test Signal	100 mA	10 mA	1 mA	100 μA	10 μA		1 μA	
Accuracy ⁴	±(0.25% + 1 LSD + 0.5% R reading)	±(0.25% + 1 LSD + 0.5% Rreading)					±(0.25% + 1 LSD + 0.5% Rreading)	
R - Range	1	2	3	4	5	6	7	8
Full Scale	2 Ω	20 Ω	200 Ω	2 kΩ	20 kΩ	200 kΩ	2 MΩ	2 MΩ ²
Resolution	1 mΩ	10 mΩ	0.1 Ω	1 Ω	10 Ω	100 Ω	1 kΩ	1 kΩ
Test Signal	100 mA	10 mA	1 mA	100 μA	10 μA		1 μA	
Accuracy	±(0.25% + 1 LSD + 0.5% L reading)	±(0.25% + 1 LSD + 0.5% Lreading)					±(0.25% + 1 LSD + 0.5% Lreading)	
D - Range	1	2	3	4	5	6	7	8
Full Scale	1.999 ³							
Resolution	0.001							
Accuracy ⁴	±(1% + 0.002) for L or C > 200 counts ±(2% + 0.01) for L or C. 50 to 199 counts							±(5% + 0.01)

Impedance Models:

Parallel for C and G:

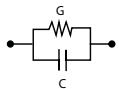

Series for L and R:

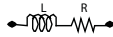

Test Conditions:

1. After correction for test lead zero reading.
2. After 10 minute warm up.
3. Between 15°C and 35°C.

Test Frequency: 1 kHz ±1%.

Measurement Rate: 2.5 measurements per second.

Analog Outputs: Impedance quantity and dissipation D are simultaneously available at the rear panel, scaled at 1 V/1000 counts; accuracy: ±(0.25% of display + 1 mV).

Digital Output (Optional): 3-1/2 digit, BCD, for data and 3 bits for range; TTL, positive true.

Current Output (Optional): 4-20 mA corresponding to 0-2000 counts of display.

Input Protection: Diode and resistor discharge network.

External dc Bias: Up to 100 V, floating, may be applied across a capacitive component through screw terminals on the rear panel terminal strip; 0.1 A maximum.

Power Requirements: 105-125 V or 210-250 V, 50-60 Hz; 5 W.

Calibration Interval: 12 months.

Dimensions: 21.6 cm W x 11.4 cm H x 30.5 cm D (8.5" x 4.5" x 12.0")

Weight: 6.8 kg (15 lb).

NOTES

* HSC Option High sensitivity capacitance range option. 20 pF full scale; 0.01 pF resolution; 1.0Vrms test signal; accuracy⁴ (±0.25% + 0.3 pF).

** HSL Option High sensitivity inductance range option. 20 μH full scale; 0.01 μH resolution; 100 mA test signal; accuracy⁴ ±(0.25% + 0.5 μH).

1. Capacitance: Higher capacitance (>200 μF) may be measured on the inductance function by the following conversion: Series model capacitance $C = 2.533 \times 10^{-8} / L$.

2. Resistance: Higher resistance (>2 MΩ) may be measured on the conductance function Range 1: R (in ohms) = $1/G$ (in siemens).

3. Dissipation (D or 1/Q): Obtain D values by pressing D button. Values greater than 1.999 may be computed as follows:

$$D = G/2\pi f c = 1.592 G'/C'$$

$$Q = 2\pi f L/R = 0.628 L'/R'$$

where G', C', L', and R' are in counts on the same range.

4. Accuracy: After correction for test lead zero reading; 15°C - 35°C; C, L, G, or R readings are in absolute counts; ignore decimal point.

ORDERING INFORMATION

IMF-600A-110 Digital Impedance Meter; 110 Vac operation
 IMF-600A-220 Digital Impedance Meter; 220 Vac operation
 IMF-600AR Autoranging Digital Impedance Meter
 -HSC Option High Sensitivity Capacitance (20 pF Range)
 -HSL Option High sensitivity inductance (20 μH Range)
 -DO Option Digital output of reading and range
 -I Option Current output (4-20 mA corresponding to 0-2000

counts of display)
 LC-603 Single Channel Digital Limits Comparator (Requires DO option; may be cascaded)
 BP-511 Portable ac Source, 115 V, 60 Hz, 300 W (see p. 48)



IET LABS, INC. in the GenRad Tradition
 534 Main Street, Westbury, NY 11590

www.ietlabs.com
 TEL: (516) 334-5959 • (800) 899-8438 • FAX: (516) 334-5988

LCR-500

The LCR-500 is an economical powerful hand-held LCR meter with features rivaling expensive benchtop systems.

- 1 mΩ to 10 MΩ;
0.1 pF to 10 mF;
0.1 μH to 10,000 H
- Autoranging and manual ranging
- Two frequency operation: 120 Hz and 1 kHz
- Sorting capability with selectable tolerances
- True bridge complex impedance capacity, L/C/R values as well as simultaneous D/Q (Dissipation/Quality)
- Auto power off; uses standard 9 V battery
- Operating guide attached to unit
- Automatic statistics



LCR-500 Handheld Impedance Meter

SPECIFICATIONS

CAPACITANCE (C)

Full scale ranges: 1,000 pF to 10 mF, in 8 ranges.

Resolution: 0.1 pF, 0.001 mF

Accuracy¹:

Range	120 Hz	1 kHz
10 mF	±(5.0% + 5 LSD)	NA
1,000 μF	±(1.0% + 5 LSD)	±(5.0% + 5 LSD)
100 μF	±(0.7% + 3 LSD)	±(1.0% + 5 LSD)
1,000 nF, 10 μF	±(0.7% + 3 LSD)	±(0.7% + 3 LSD)
100 nF	±(0.7% + 5 LSD)	±(0.7% + 3 LSD)
10 nF	±(1.0% + 5 LSD)	±(0.7% + 5 LSD)
1,000 pF	NA	±(1.0% + 5 LSD)

D (Dissipation): ±(0.7% + 100/C rdg + 5 LSD), basic accuracy.

Impedance Model:

INDUCTANCE (L)

Full scale ranges: 1 mH to 10,000 H in 8 ranges.

Resolution: 0.1 μH - 1 H

Accuracy^{1,2}:

Range	120 Hz	1 kHz
10,000 H	5% typical	NA
1,000 H	±(1.0% + 5 LSD)	5% typical
100 H	±(0.7% + 5 LSD)	±(1.0% + 5 LSD)
1 H, 10 H	±(0.7% + 5 LSD)	±(0.7% + 5 LSD)
100 mH	±(1.0% + 5 LSD)	±(0.7% + 5 LSD)
10 mH	±(2.0% + 5 LSD)	±(1.2% + 5 LSD)
1 mH	NA	±(2.0% + 5 LSD)

D (1/Q): ±(1.2% + 100/L rdg + 5 LSD), basic accuracy.

Impedance Model:

1) LSD: Least significant digit 2) + (L counts x 10⁻⁴)%.

RESISTANCE (R)

Full scale ranges: 10 Ω to 10 MΩ, in 7 ranges.

Resolution: 1 mΩ - 0.001 MΩ

Accuracy¹:

Range	Accuracy
10 MΩ	±(2.0% + 8 LSD)
1 MΩ	±(0.5% + 5 LSD)
1 kΩ - 100 kΩ	±(0.5% + 3 LSD)
100 Ω	±(0.8% + 5 LSD)
10 Ω	±(1.2% + 8 LSD)

GENERAL SPECIFICATIONS

Displays:

L/C/R: Maximum display of 9999 except at 10 mF (120 Hz) and 1 mF (1 kHz) measurement ranges which have a maximum display of 1999.

D/Q: 3 digits, maximum display 999 (autorange).

Status: Annunciators for units, low battery, frequency, open fuse; audio tone for tolerance testing, and other test conditions.

Ranging mode: Auto and manual.

Test frequency: 1 kHz and 120 Hz.

Test signal level: 0.9 Vrms approximately.

Measurement rate: 1 measurement/second, nominal.

Measurement terminals: 2 banana jacks and 2 easy-insert component sockets.

Operating modes: Relative, calibration, tolerance sorting, and max/min/avg recording.

Input protection: 70 mA fast-blow 250 V fuse.

Auto power-off time: Approximately 5 minutes; may be disabled.

Power Requirements:

1) Battery, 9V;

2) External adapter, 12-15 Vdc, 50 mA.

Dimensions: 19.2 cm L x 9.0 cm W x 3.7 cm H (7.56" x 3.54" x 1.46").

Weight: 390 g (3 oz).

ORDERING INFORMATION

LCR-500	Autoranging LCR meter
LCR-5001	AC adapter, 110 V
LCR-5001-220	AC adapter, 220 V
LCR-5002	Carrying case
CC-25	Component clip



IET LABS, INC. in the GenRad Tradition
534 Main Street, Westbury, NY 11590

www.ietlabs.com
TEL: (516) 334-5959 • (800) 899-8438 • FAX: (516) 334-5988

LOM-510A Series

p. 1 of 2

Features and accessories to assure that very low resistance measurements are accomplished accurately, easily, and economically.

- 1 $\mu\Omega$ resolution
- 0.02% basic accuracy
- Digital output
- Four measurement modes
- Auto-zero switched dc mode
- Probes for chips and traces

HIGH PERFORMANCE LOW RESISTANCE MEASUREMENT

The LOM-510A has 4½ digits, 0.02% basic accuracy and 1 $\mu\Omega$ resolution. Its 4-terminal measurement technique eliminates lead resistance errors and 80 dB of ac noise rejection provides rock-steady readings even in noisy locations. The unit comes with rugged 4-terminal test clips and a large selection of optional probes, clips and fixtures allowing attachment to any low-resistance unknown.

Switched dc Mode:

Allows measurement of switch contacts, welds, shunts, PC board tracks and other primarily resistive elements. Thermal emf effects are eliminated.

Constant dc Mode:

Suitable for measuring the resistance of inductive components such as coils or transformers.

Pulsed Mode:

Provides low drive current to allow measurements of fuses, thermistors, and other thermally sensitive devices.

Dry Circuit:

Assures that oxides and film contacts are not punctured. The Dry Circuit Mode limits the open circuit voltage to 50 mV. The Model LOM-510A/20 limits the open circuit voltage to 20 mV.



Model LOM-510A Micro-ohmmeter shown with LOM-501 Standard 4-Terminal Kelvin clips

PORTABLE POWER, RUGGED, AND MORE

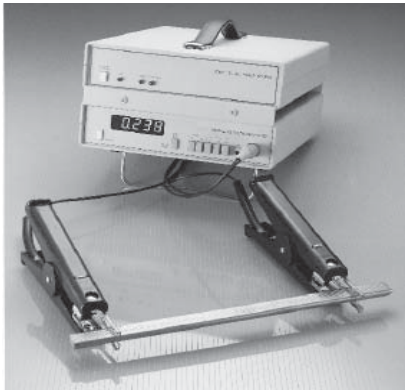

Model LOM-510A shown with LOM-504 heavy duty Kelvin clips

Portability permits many field applications such as the measurement of very low resistances of rail or pipe bonds, welds, airframes, motors, transformers, and power distribution apparatus.

The optional Model BP-511 Battery Driven ac Power Source will operate the micro-ohmmeter from its internal battery for more than an hour continuously, worst case, and for an indeterminately large number of hours when used in normal operation. In addition, the 40 watt, 120 Vac, 60 Hz output can be used to make almost any other small instrument or tool portable.

The BP-511 AC Power Source can be mechanically attached to the micro-ohmmeter with the optional Model LOM-513 coupler kit, and both units come in heavy-duty metal cases. A built-in battery charger is provided as are LED's to indicate low-battery conditions and charger operation. See the BP-511 Battery Driven ac Power Source data sheet.

LOM-510A Series

p. 2 of 2

SPECIFICATIONS

LOM-510A MICRO-OHMMETER

Accuracy:

Model LOM-	SW (Switched dc)	DC (Continuous dc)	Pulsed Mode
510A	0.02% + 2 counts + 2 $\mu\Omega$	0.04% + 2 counts + 2 $\mu\Omega$	0.02% + 4 counts + 2 $\mu\Omega$
510A/20	0.03% + 3 counts + 2 $\mu\Omega$	0.05% + 3 counts + 2 $\mu\Omega$	0.03% + 4 counts + 2 $\mu\Omega$

Range (Full Scale)	Drive	Max Dissipation		Resolution
		DC	SW	
19,999 m Ω	1 A	20 mW	5.0 mW	1 $\mu\Omega$
199.99 m Ω	.1 A	2.0 mW	.50 mW	10 $\mu\Omega$
1.9999 Ω	10 mA	.2 mW	.05 mW	100 $\mu\Omega$
19.999 Ω	1 mA	.02 mW	.005 mW	1 m Ω
1.99.99 Ω	.1 mA	.002 mW	.0005 mW	10 m Ω

Zero Adjust: Active only in DC (Continuous dc) mode.

Noise Rejection: 80 dB for SW (Switched dc) and Pulsed Mode; 60 dB for DC (Continuous dc) mode.

SW (Switched dc) Mode: Current switched on for 166 ms, then off for 500 ms (duty cycle = 0.25).

ACCESSORIES

LOM-501 4-Terminal-Kelvin Clips: The Model 501 test clips are fully insulated and their 1/4 inch jaw openings will accommodate almost any electronic component. They have miniature tips for grasping very fine wires and other small items. Lead length is 1 m (39").



LOM 501A: Same as LOM-501; leads are 2 m (79") long.

LOM-502 4-Terminal Kelvin Clips: Pair of clips, same as Model LOM-501, but unwired.

LOM-504 4-Terminal Heavy-Duty Kelvin Clips: (Shown with Model LOM-510A Micro-ohmmeter, previous page, center). The Model LOM-

Pulsed Mode: One cycle of SW (Switched dc) mode; enabled by shorting two contacts on rear panel connector.

Display: 4½ digit, 0.5 inch, red LED display.

Display Overrange Indication: Flashes for DC (Continuous dc) and SW (Switched dc); blanks in Pulsed mode.

Measurement Rate: 1.5 readings/second.

Connections to Unknown: 4-terminal Kelvin leads with shield.

Outputs: 5 BCD digits for value and polarity; Pulsed Mode Control lines; power supply lines; 25 pin "D" connector.

Warm up time: 1 minute to rated accuracy.

Accuracy vs. Temperature: Stated accuracy applies over an ambient temperature range of 18 to 27 °C. Error doubles over the range of 10 to 40 °C.

Accessories Supplied: LOM-501 test clips.

Power Requirements: 105-125 V or 210-250 V, 50-60 Hz, 30 W max.

Dimensions: 22.9 cm W x 5.1 cm H x 27.9 cm D (9" x 2" x 11")

Weight: 2.7 kg (6 lb).

504 probe set has 1.9 cm (1.75") jaw openings and 3.7 m (12') lead lengths that permit measurements on large bushings, welded and bolted joints, rails and pipes, transformers and motors, fuses, power distribution busses or nearly any other large electrical components.

LOM-506 4-Terminal Kelvin Microprobes: The Model LOM-506 microprobes permit measurement of chips, circuit board components, and fine conductor traces. They also make measurements possible in areas which are inaccessible to other probes, such as inside a connector. The finely-pointed, spring-loaded tips are on 1.27 mm (.05") centers. They are made from hardened beryllium copper, gold plated over nickel plate. They are replaceable



LOM-512 COMPUTER INTERFACE AND LIMITS COMPARATOR

Serial Output: Allows connection to RS-232C interface of a computer or a printer. Can be converted to true RS-232C with simple external circuit for applications requiring cable lengths in excess of twelve feet.

Additional TTL-compatible output signals on rear panel connector: Low Limit Exceeded, High Limit Exceeded, Data Ready.

Input: Trigger measurement - initiates a single measurement cycle, TTL-compatible, available at rear panel connector.

Pulse Mode Enable & Trigger Switches: Allow manual operation of the single measurement mode of operation of Model LOM-510A. Useful for measurements on thermally sensitive components.

Power Requirements: Powered by LOM-510A Micro-Ohmmeter.

Accessories Supplied: Model LOM-512-1 adapter cable.

Dimensions: 22.9 cm W x 5.1 cm H x 27.9 cm D (9" x 2" x 11").

Weight: 2.3 kg (5 lb).

ORDERING INFORMATION

LOM-510A-110 Digital Micro-ohmmeter w/LOM-501 test clips; 110 Vac oprtn.
LOM-510A-220 Digital Micro-ohmmeter w/LOM-501 test clips; 220 Vac oprtn.
LOM-510/20 Digital Micro-ohmmeter, w/20 mV dry circuit option, and w/LOM-501 test clips

LOM-530 Calibration Kit for LOM 510-A
BP-511 Battery Pack, AC Source, 115 V, 60 Hz, 40 W (see p. 45)

LOM-512 Computer Interface-Digital Comparator for Model LOM-510A.

LOM-501 Kelvin Test Clips (pair, length 1 meter)

LOM-501A Kelvin Test Clips (pair, length 2 meters)
LOM-502 Kelvin Test Clips, without cable (pair)
LOM-503 Kelvin Test Clips, E-Z Hooks (length 1 meter)
LOM-504 Kelvin Test Clips, Heavy Duty, 2 inch jaws pair, length 1 meter)

LOM-506 Kelvin Microprobes (pair, length 1 meter)
LOM-506-1 Replacement Microprobes, set of 4
BP-511-1 Adapter Cable, power, connects LOM-510A to BP-511, (supplied with model BP-511)

LOM-512-1 Adapter cable, data, connects LOM-510A to LOM-512, (supplied with model LOM-512)

LOM-513 Coupler Kit (attaches BP-511 or LOM-512 to LOM-



BP-511

The 600 VA, 20 Vac, 60 Hz output of the Model BP-511 Battery Driven ac Power Source can be used to operate virtually any tool, IET instrument, or other electronic device in the field or other location where normal power is

not available. It has been used to operate oscilloscopes, DVM's, and other instruments as well as soldering irons and power tools.

- Makes almost any lab instrument portable
- Small size
- Up to 600 VA, 345 W
- Charging and low battery indicators

SPECIFICATIONS

Outputs: 120 V, 60 Hz; other voltages and frequencies available.

Output Power: 700 VA, 345 W.

Output Voltage Regulation: PWM sine wave 120 V \pm 5%

Output Frequency Regulation: 60 Hz \pm 0.5 Hz.

Indicators: Line power status; battery power status; and battery low status.

Charge Power Requirements: 105-125 V or 210-250 V, 50-60 Hz.

Battery Recharge Time: 2-4 hours to 90%.

Operating Temperature: +32 to +104°F

Dimensions: 13.3 cm W x 27.3 cm H x 18.4 cm D
(5.25" x 10.75" x 12.0")

Weight: 8.6 kg (19 lb).

ORDERING INFORMATION

BP-511 Battery Pack, ac Source, 115 V, 60 Hz, 700 VA



Please see the Remote programming
software and hardware tools in the PRS
Series pp 23-26.



Part 2

Standards and Instruments formerly manufactured by **GenRad**

STANDARDS • DECADES • STROBES • BRIDGES • AUDIO



1482 Standard Inductor	p. 51	1565-B Sound Level Meter	p. 70
1491 Decade Inductor	p. 53	1562-A Sound Level Calibrator	p. 71
1404 Standard Capacitor	p. 55	1531-AB and 1538-A Strobes	p. 72
1408 Standard Capacitor	p. 57	1539-A Stroboscopic Light Source	p. 74
1409 Standard Capacitor	p. 58	1542-B Strobotac® Stroboscope	p. 76
1412-BC Decade Capacitor	p. 60	1546 Strobotac® Digital Stroboscope	p. 78
1413 Precision Decade Capacitor	p. 62	1620-A Precision Cap. Meas. System	p. 80
1417 4-Terminal Capacitance Standard.....	p. 64	1621 High Precision Cap. Meas. System.....	p. 85
1422 Precision Variable Air Capacitor	p. 66	Other GenRad Products	Consult IET
1433 Precision Decade Resistor	p. 68		



1482 Series

p. 1 of 2

The 1482 is an accurate, highly stable standard of self-inductance for use as a low frequency reference or working standard in the laboratory. Records extending over 40 years, including those of inductors that traveled to national laboratories in several countries for calibration, show long-term stability well within $\pm 0.01\%$, typically much lower.

- A standard for national laboratories
- Stability within $\pm 0.01\%$ per year; typically much better
- Values from 10 μH to 10 H
- Standard for quality factor
- Low, known temperature coefficient
- Self-shielding toroidal design



Model 1482 Precision Inductor

Each inductor is a uniformly wound toroid on a ceramic core. It has a negligible external magnetic field and hence essentially no pickup from external fields. The inductor is resiliently supported in a mixture of ground cork and silica gel, after which the whole assembly is cast with a potting compound into a cubical aluminum case. Sizes

of 1 mH and above have three terminals, two for inductor leads and the third connected to the case, to provide either a two- or three-terminal standard. The 100 μH size has three additional terminals for the switching used to minimize connection errors.

SPECIFICATIONS

Inductance Range: See table.

Accuracy of Adjustment: See table.

Calibration: A certificate of calibration is provided with each unit, giving measured values of inductance at 100, 200, 400, and 1000 Hz, with test conditions and method of measurements specified. These values are obtained by comparison, to a precision, typically, of better than $\pm 0.005\%$, with standards whose absolute values, traceable to the International System of Units (SI), are known to an accuracy typically of $\pm(0.02\%+0.1 \mu\text{H})$ at 100 Hz; $\pm(0.1\%+0.1 \mu\text{H})$ for the 1482-B

Stability: Inductance change is less than $\pm 0.01\%$ per year.

DC Resistance: See table for representative values. A measured value of resistance at a specified temperature is given on the certificate of calibration.

Low-Frequency Storage Factor Q:

See table for representative values of Q at 100 Hz (essentially from dc resistance). An individual value of Q is given on each certificate of calibration.

Temperature Coefficient of Inductance: Approximately 30 ppm/ $^{\circ}\text{C}$. Small temperature corrections may be computed from resistance changes.

A 1% increase in resistance, produced by temperature increase of 2.54°C corresponds to 0.0076% increase in inductance.

Resonant Frequency: See table for representative values. A measured value is given on the certificate of calibration.

Maximum Input Power: For a rise of 20°C , 3 W; for precise work, a rise of 1.5°C , 200 mW. See table for corresponding current limits.

Terminals: 5-way binding posts with $\frac{3}{4}$ -in spacing with removable ground strap.

Dimensions: 16.6 cm H x 16.6 cm W x 20.4 cm D (6.5" x 6.5" x 8").

Weight: 5.3 kg (11.5 lb) net, 6 kg (13 lb) shipping.



1482 Series

p. 2 of 2

Description	Nominal Inductance	Adjustment Accuracy (%)	*Resonant Frequency (kHz)	*dc Resistance (Ω)	*Q at 100 Hz	mA rms for:	
						200 mW	3 W
1482-AA	10 μ H	\pm 1%	4500	0.03	0.75	2500	9000
1482-A	50 μ H	\pm 0.5	3100	0.039	0.81	2260	8770
1482-B	100 μ H	\pm 0.25	2250	0.083	0.76	1550	6010
1482-C	200 μ H	\pm 0.25	1400	0.15	0.84	1150	4470
1482-D	500 μ H	\pm 0.1	960	0.38	0.83	725	2810
1482-E	1 mH	\pm 0.1	800	0.84	0.75	490	1890
1482-F	2 mH	\pm 0.1	580	1.52	0.83	360	1400
1482-G	5 mH	\pm 0.1	320	3.8	0.83	230	890
1482-H	10 mH	\pm 0.1	220	8.2	0.77	156	600
1482-J	20 mH	\pm 0.1	145	14.5	0.87	117	450
1482-K	50 mH	\pm 0.1	84	36.8	0.85	74	280
1482-L	100 mH	\pm 0.1	71	81	0.78	50	192
1482-M	200 mH	\pm 0.1	39.0	109	1.15	43	166
1482-N	500 mH	\pm 0.1	24.5	280	1.12	27	103
1482-P	1 H	\pm 0.1	14.6	616	1.02	18	70
1482-Q	2 H	\pm 0.1	10.6	1125	1.12	13.3	52
1482-R	5 H	\pm 0.1	6.8	2920	1.08	8.3	32
1482-T	10 H	\pm 0.1	4.9	6400	0.98	5.6	22

*Representative values. Actual values given on certificate

ORDERING INFORMATION

1482-9700	1482-AA Standard Inductor, 10 μ H	1482-9710	1482-J Standard Inductor, 20 mH
1482-9701	1482-A Standard Inductor, 50 μ H	1482-9711	1482-K Standard Inductor, 50 mH
1482-9702	1482-B Standard Inductor, 100 μ H	1482-9712	1482-L Standard Inductor, 100 mH
1482-9703	1482-C Standard Inductor, 200 μ H	1482-9713	1482-M Standard Inductor, 200 mH
1482-9704	1482-D Standard Inductor, 500 μ H	1482-9714	1482-N Standard Inductor, 500 mH
1482-9705	1482-E Standard Inductor, 1 mH	1482-9716	1482-P Standard Inductor, 1 H
1482-9706	1482-F Standard Inductor, 2 mH	1482-9717	1482-Q Standard Inductor, 2 H
1482-9707	1482-G Standard Inductor, 5 mH	1482-9718	1482-R Standard Inductor, 5 H
1482-9708	1482-H Standard Inductor, 10 mH	1482-9720	1482-T Standard Inductor, 10 H



1491 Series

p. 1 of 2

The 1491 Decade Inductor is an assembly of several Decade-Inductor Units in a single metal cabinet. The units have no electrical connection to the panel, but a separate ground terminal is provided, which can be connected to the adjacent low terminal, leading to the smallest decade.

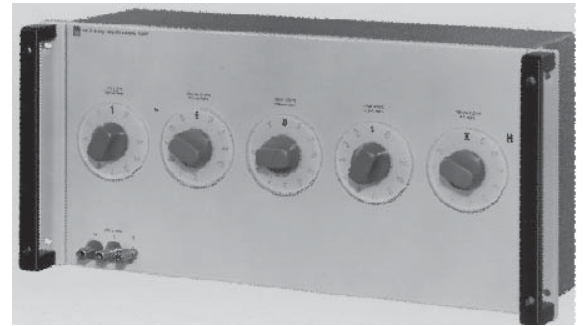

Model 1491 Precision Inductor

- Shielded toroidal cores for small mutual inductance and minimal effect from external fields
- Sealed against moisture for long-term stability
- Excellent as a moderately precise standard of inductance
- High-Q, 200 and above

These inductance decades are convenient elements for use in wave filters, equalizers, and tuned circuits throughout the range of audio and low radio frequencies. As components in oscillators, analyzers, and similar equipment, they are especially useful during the preliminary design period, when you need to vary circuit elements

over relatively wide ranges to determine optimum operating values. As moderately precise standards of inductance they have values of low-frequency storage factor, Q, that are much larger than those of air-core coils.

Figure 1: Percentage change in normal and incremental inductance with ac and bias current. Incremental curve is limited to and ac excitation less than I_1 .

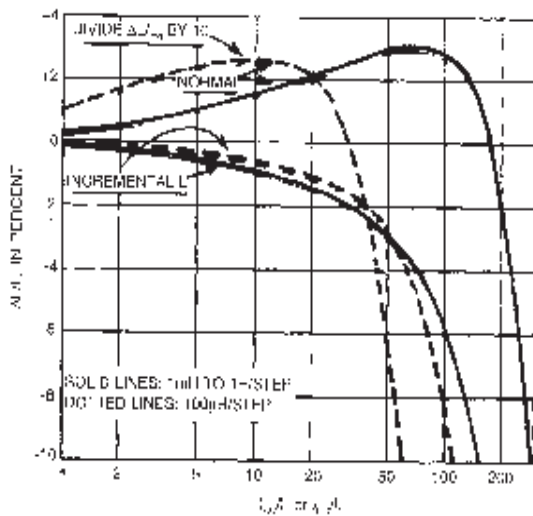

Figure 2: Variation of inductance with frequency for the 1491 Decade Inductors.

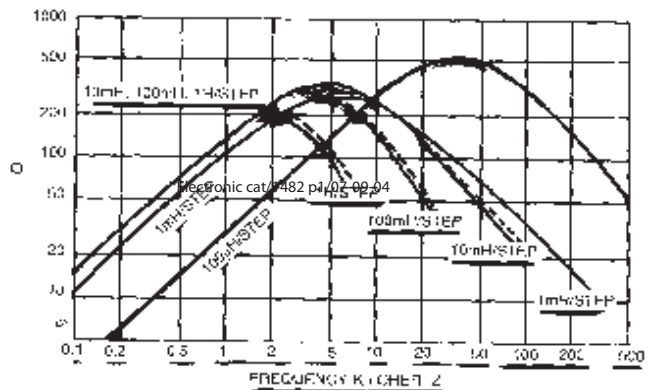
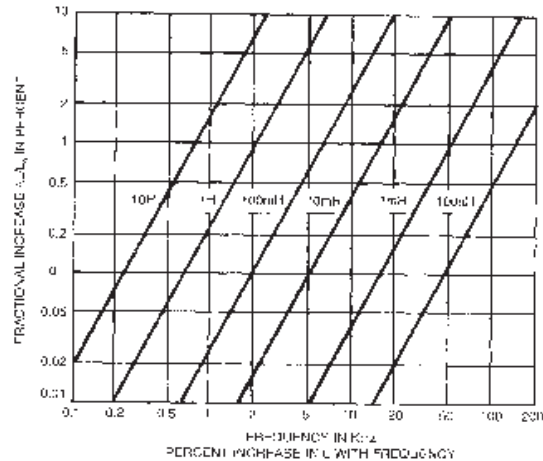

Figure 3: Variation to Q for the maximum inductance at low excitation levels. Dashed curves correspond to use with chassis floating.



1491 Series

p. 2 of 2

SPECIFICATIONS

Frequency Characteristics: Percentage increase in effective series inductance (above the zero-frequency value, L_0) may be obtained by interpolation in accompanying graph (see Figure 2) for any setting to the highest-value decade used, when LOW terminal is grounded to cabinet.

Zero Inductance: Approximately 1 μ H

Maximum Voltage: 500V rms. Switch will break circuit at 500V if turned rapidly, but voltages above 150V may cause destructive arcing with switch between detent positions.

Accuracy (Low Frequency, Low Signal Level):

Model	Inductance Per Step				
	100 μ H	1 mH	10 mH	100 mH	1 H
1491-9704	N/A	$\pm 2\%$	$\pm 1.6\%$	$\pm 0.8\%$	$\pm 0.8\%$
1491-9707	$\pm 2\%$	$\pm 2\%$	$\pm 1.6\%$	$\pm 0.8\%$	$\pm 0.8\%$

Change in Inductance with Current: Fractional change in initial inductance with AC current for each type of toroid is shown in the normal curves, Figure 1, in terms of the ratio of the operating current, I , to I_1 the current for 0.25% change, solid line (0.1%, broken line). For ratios below unity, inductance change is directly proportional to current. Values of I_1 , listed below, are approximate and are based on the largest inductor in the circuit for each setting.

Storage Factor Q: See Figure 3.

dc Resistance: Approximately 45 Ω per Henry.

Switch Setting		RMS I_1 (mA)			
		0.1% Increase	0.25% Increase		
			100 μ H	10 mH	100 mH
1	141	17	5.4	1.7	.54
2,3,4	100	12	3.8	1.2	.38
5,6,7,8,9,10	63	8	2.4	0.8	.24
Maximum I	4 A	1.5 A	500 mA	150 mA	50 mA

Storage Factor Q: See Figure 3.

DC Resistance: Approximately 45 Ω per Henry.

Temperature Coefficient: Approximately -25 ppm/ $^{\circ}$ C between 16 $^{\circ}$ and 32 $^{\circ}$ C.

Terminals: Binding posts on 3/4-in centers; separate ground terminal provided.

Mechanical: Lab-bench cabinet.

Dimensions: 22.3 cm H x 43.2 cm W x 16.6 cm D (8.75" x 17" x 6.5").

ORDERING INFORMATION

1491-9704 1491-D, Decade Inductor, 11.11 H, 1 mH/Step

1491-9707 1491-G, Decade Inductor, 11.111 H, 100 μ H/Step



1404 Series

p. 1 of 2

These capacitors have been designed as primary reference standards of capacitance with which working standards can be compared. IET's 1620A and 1621 Precision Capacitance Measuring Systems are particularly well suited for this purpose and can be conveniently used to calibrate accurately a wide range of working standards in terms of a 1404 Reference Standard Capacitor.

- A national laboratory standard
- For calibrating working standards
- Standard for dissipation factor
- Available in 10, 100 and 1000 pF
- 20 ppm/year stability, typically better
- Hermetically sealed in dry nitrogen



Model 1404 Standard Capacitor

In combination with an accurately known external resistor, this capacitor also becomes a standard of dissipation factor.

All critical parts of the plate assembly are made of invar for stability and low temperature coefficient. After heat cycling and adjustment the assembly is mounted in a heavy brass container, which after evacuation, is filled with dry nitrogen under pressure slightly above atmospheric and sealed. The container is mounted on an aluminum

panel and protected by an outer aluminum case. Each capacitor is subjected to a series of temperature cycles to determine hysteresis and temperature coefficients and to stabilize the capacitance.

Two locking bnc coaxial connectors are used as terminals (other connectors such as 874 type are available as options). The outer shell of one is connected to the case, but the outer shell of the other is left unconnected to permit the capacitor to be used with an

Figure 1
Equivalent circuit showing direct capacitance, C_D , and average values of residual inductance, L , and terminal capacitances, C_H and C_L .
 $C_D = 1000$ pF for 1404-A,
100 pF for 1404-B, and
10 pF for 1404-C.

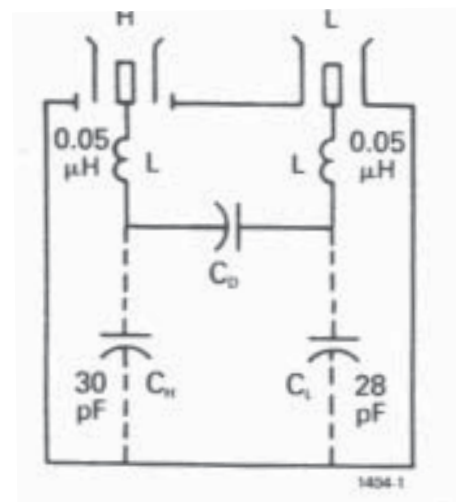

1404 Series

p. 2 of 2

SPECIFICATIONS

Calibration: A certificate of calibration is supplied with each capacitor, giving the measured direct capacitance at 1 kHz and $23^{\circ} \pm 1^{\circ}\text{C}$. The measured value is obtained by a comparison to a precision better than ± 1 ppm with working standards whose absolute values are known to an accuracy of ± 5 ppm, determined and maintained in terms of reference standards periodically measured by the National Institute of Standards and Technology.

Adjustment Accuracy: The capacitance is adjusted before calibration with an accuracy of ± 5 ppm to a capacitance about 5 ppm above the nominal value relative to the capacitance unit maintained by the reference standards.

Stability: Long term drift is less than 20 ppm per year. Maximum change with orientation is 10 ppm and is completely reversible.

Temperature Coefficient of Capacitance: 2 ± 2 ppm/ $^{\circ}\text{C}$ for 1404-A and -B, 5 ± 2 ppm/ $^{\circ}\text{C}$ for 1404-C, from -20°C to $+65^{\circ}\text{C}$. A measured value with an accuracy of ± 1 ppm/ $^{\circ}\text{C}$ is given on the certificate.

Temperature Cycling: For temperature cycling over range from

-20°C to $+65^{\circ}\text{C}$, hysteresis (retraceable) is less than 20 ppm at 23°C .

Dissipation Factor: Less than 10^{-5} at 1 kHz.

Residual Impedance: See Figure 1 for typical values of internal series inductance and terminal capacitance.

Max Voltage: 750 V.

Terminals: Two BNC coaxial connectors (legacy locking G874 coaxial connectors are available). Outer shell of one connector is ungrounded to permit capacitor to be used with external resistor as a dissipation factor standard.

Mechanical: Lab-bench cabinet.

Dimensions: 16.9 cm H x 17.2 cm W x 20.4 cm D (6.63" x 6.75" x 8").

Weight: 3.9 kg (8.5 lb.) net, 6.4 kg (14 lb.) shipping.

ORDERING INFORMATION

1404-9701 1404-A, 1000 pF
1404-9702 1404-B, 100 pF

1404-9703 1404-C, 10 pF



1408-9706 Capacitor Series

Ultra-high stability. The continuously improving accuracy of capacitor calibrations by NIST brings a better knowledge of capacitance to standards laboratories - provided, of course, the laboratories have adequate reference standards. The 1408 Reference Standard Capacitors, with their high stability, are suitable for calibration in parts in 10^7 . The 1616 Precision Capacitance Bridge is highly recommended for accurate calibration of a wide range of working standards from such a reference.

This unit includes two standards, 10 pF and 100 pF, plus a self-contained air bath whose temperature is held constant to within 0.01 per year to assure the utmost stability of the standards. Since it carries its own environment, it is well adapted for use in laboratories without an oil bath or closely-controlled ambient temperature or in portable laboratories and calibration centers. The air bath operates from 12 volts so that it is an easy matter to transport it under power at all times.

- 10 pF and 100 pF combination
- High stability
- Low voltage coefficient

SPECIFICATIONS

Nominal Value: 10 pF and 100 pF.

Calibration: A certificate of calibration is supplied with each capacitor, giving the measured direct capacitance at 1 kHz and at the specified temperature near 30°C, the air-bath temperature. The measured value is obtained by a comparison to a precision better than 0.5 ppm with standards whose values are determined and maintained by periodic calibrations made by NIST.

Adjustment Accuracy: ± 5 ppm.

Stability: Estimated to be better than 1 ppm per year.

Temperature Coefficient: 2 ± 2 ppm/°C for 100 pF;
 5 ± 2 ppm/°C for 10 pF.

Temperature Cycling: from 0 to 60°C, < 1 ppm hysteresis at 30°C.

Electrical:

- Dissipation Factor: $< 10^{-5}$ at 1 kHz.
- Voltage: 750 V max.
- Residual Impedances: See Figure 1

Fig.1

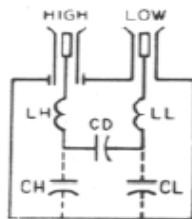

Value (pF)	LH, LL (μH)	CD (pF)	CH (pF)	CL (pF)
10	0.05	100	30	28
100	0.05	100	30	28

Terminals: Two locking G874 coaxial connectors or BNC connectors; various patch cords available.

Air-Bath Characteristics:

- Temperature: 30°C nominal with stability of 0.01°C/year, <0.005°C/hour if ambient temperature is kept within 1°C.
- Temperature Coefficient: $0+0.05$ ppm/°C from 17 to 29°C ambient temperature; thermometer well provided for calibration.

General: Connectors can be made to the front or the rear as your application dictates. A 12-volt input is provided to maintain a constant air-bath temperature even while the unit is in transit.

Power: 105 to 125 V or 210 to 250 V, 50 to 60 Hz, 5 W; 12 V at 0.4 A; for dc operation, battery connectors provided on rear.

Mechanical:

Dimensions: 22.2 cm H x 21.4 cm W x 40.7 cm D (8.72" x 8.42" x 16"); (approx.)

Weight: 12 kg (25 lb.) net, 16 kg (34 lb.) shipping; (approx.)

ORDERING INFORMATION

1408-9706 10/100 pF Air bath Reference Standard Capacitor



Standard Capacitance Reference or Working Standard

1409 Series

p. 1 of 2

Highly stable cost-effective capacitance standards with low temperature coefficient, low losses and a wide range of values.

- 0.001 μF to 1000 μF
- $\pm 0.01\%$ /year stability
- Verify meter and instrumentation calibration
- Two-to-five terminal configuration, depending on model



Model 1409 Standard Capacitance

SPECIFICATIONS

Calibration Accuracy: 100 ppm for 1 nF; 0.01% for 1 μF and under; 0.04% for 100 μF and under; and 0.4% for 1000 μF ;

At test frequency of 1 kHz for up to 5 μF ; 100 Hz for over 5 μF .

2-terminal and 3-terminal measurements are provided.

Stability: <0.01% per year.

Temperature Coefficient: 20 ppm/°C for 1 μF and under;
-50 ppm/°C for capacitance to 190 μF ;
-150 ppm/°C for 1000 μF .

Operating Temperature: 10°C to 50°C.

Dissipation Factor: 0.01 μF - 1 μF ; 0.0003 at 1 kHz;
10 μF ; 0.0005; 100 μF ; 0.001;
1000 μF ; 0.002 at 100 Hz and 120 Hz; 0.02 at 1 kHz.

Series Inductance: Typically < 0.06 μH , 0.01 μF - 1 μF .

Series Resistance at 1 MHz: 0.02 Ω , 0.01 μF - 0.1 μF ; 0.03 Ω , 1 μF .

Frequency Characteristics: Varies as \sqrt{f} above 100 kHz. See figure 1.

Leakage Resistance: 5,000 ohm-Farads or 100 G Ω , whichever is less.

Max Voltage: See table.

Test Conditions: (100 Hz, 120 Hz and 1 kHz at 23°C; < 1 μF ; 5 - terminal measurement for values 1 μF , 1 MHz or other available.

Capacitor Type: Hermetically sealed silvered mica for 100 pF to 1 μF ; hermetically sealed polystyrene for 10 μF ; hermetically sealed polycarbonate for >10 μF .

Terminals: Three binding posts, for values up to 1 μF ;
five binding posts, for values over 1 μF .

Dimensions:

-F/L/T: 10.2 cm H x 8.3 cm W x 5.1 cm D
(4.0" x 3.3" x 2.0")

-Y: 14.3 cm H x 8.3 cm W x 6.9 cm D
(5.6" x 3.2" x 2.7")

-10 μF /100 μF : 86 cm H x 10.5 cm W x 12.7 cm D
(3.4" x 4.15" x 5.0")

-1000 μF : 8.6 cm H x 30.5 cm W x 8.9 cm D
(3.4" x 12" x 3.5")

Weight: -F/L/T: ~ 0.6 kg (1.25 lb.)

-Y: ~ 1.1 kg (2.25 lb.)

-10 μF /100 μF : ~ 0.4 kg (0.8 lb.)

-1000 μF : ~ 2 kg (4.5 lb.)

Model	Value	Adjustment Accuracy	Dissipation Factor (typical)	Maximum Voltage** (V)
1409-F	1 nF	$\pm 0.02\%$	0.0003	500
1409-L	10 nF	$\pm 0.02\%$	0.0003	500
1409-T	100 nF	$\pm 0.02\%$	0.0003	500
1409-Y	1 μF	$\pm 0.02\%$	0.0003	500
1409-10 μF	10 μF	$\pm 0.04\%$	0.0005	44 Vrms+
1409-100 μF	100 μF	$\pm 0.05\%$	0.001	22 Vrms+
1409-1000 μF	1000 μF	$\pm 0.4\%$	0.001	22 Vrms+
1409-X	Custom	*	*	*

+ Maximum allowable Vrms; subject to maximum Vdc = 50 V and max Vrms = (39000/f) for C = 10 μF ; (26000/f) for C = 19 μF ; (13000/f) for C \geq 100 μF ; (9500/f) for C \geq 1000 μF , where f = frequency (in Hz).

* Depends on Custom value

** Peak up to 10 kHz.



1409 Series

p. 2 of 2

Figure 1
Change in capacitance as a function of frequency for typical 1409 Capacitors. The 1-kHz value on the plot should be used as a basis of reference in estimating frequency errors.

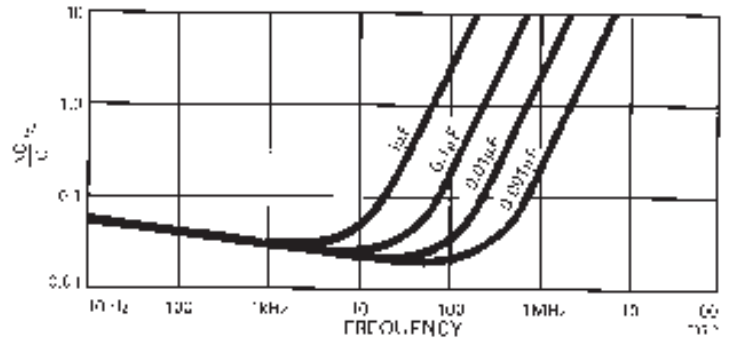
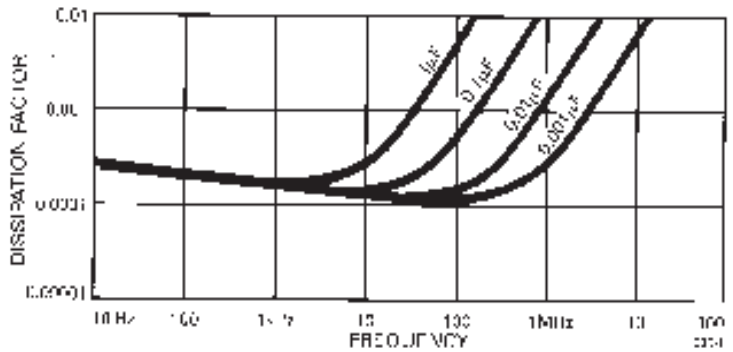

Figure 2
Dissipation factor as a function of frequency.



ORDERING INFORMATION

1409-9706	1409-F,	0.001 µF
1409-9712	1409-L,	0.01 µF
1409-9720	1409-T,	0.1 µF
1409-9725	1409-Y,	1.0 µF

1409-9730	1409,	10 µF
1409-9735	1409,	100 µF
1409-9740	1409,	1000 µF
1409-9740	1409,	Custom Value



1412 Series

p. 1 of 2

Model 1412-BC: The wide capacitance range and high resolution of this decade capacitance box make it exceptionally useful in both laboratory and test shop. Owing to its fine adjustment of capacitance, it is a convenient variable capacitor to use with an impedance comparator. The polystyrene dielectric used in the decade steps is necessary for applications requiring low dielectric absorption and constancy of both capacitance and dissipation factor with frequency.



Model 1412-BC Decade Capacitor

- Verification of calibration of LCR meters
- Capacitance measurement functions
- Verification of calibration of multimeters
- For calibrating instrumentation

- 50 pF to > 1 μ F
- Better than 1 pF resolution
- Accuracy of $\pm (0.5\% + 5 \text{ pF})$
- Low loss, leakage, dielectric absorption

For decades of polystyrene capacitors and a variable air capacitors are used, mounted in a double-shield box. The double shielding provides 2-terminal and 3-terminal capacitance's that are the same except for the capacitance between the terminals. The variable air

capacitor with a linear ΔC of 100 pF and a resolution of better than 1 pF provides continuous adjustment between the 100 pF steps of the smallest decade.

Figure 1

The double shielding used in the 1412-BC Decade Capacitor keeps C_{HG} very small. This capacitance is the difference between the 3-terminal and 2-terminal capacitance of the box; C_{LG} is approx. 125 pF.

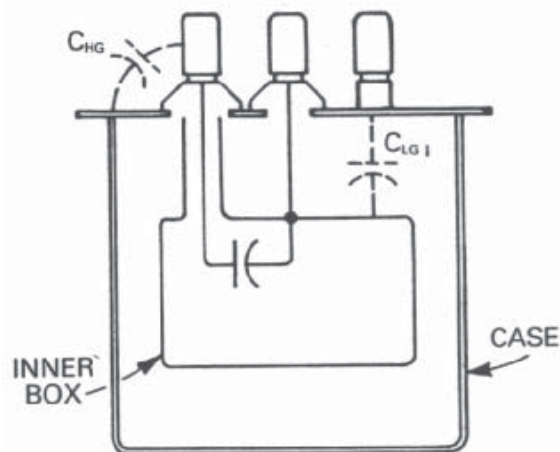

SPECIFICATIONS

Capacitance: 50 pF to 1.11115 μ F in steps of 100 pF with a 0 to 100 pF variable air capacitor providing continuous adjustment with divisions of 1 pF. Capacitance for 2- and 3-terminal connections differ by about 1 pF (C_{HG} in Figure 1) C_{LC} is approximately 125 pF.

Minimum Capacitance: 50 pF with all controls set at zero.

Dielectric: Polystyrene for decade steps.

Accuracy: $\pm(0.5\% + 5 \text{ pF})$ at 1 kHz for total capacitance including 50 pF minimum for the 3-terminal connection.

Temperature Coefficient of Capacitance: -140 ppm/ $^{\circ}$ C (nominal).

Frequency Characteristics: DC Cap/ 1 kHz Cap < 1.001. At higher frequencies the increase is approximately $\Delta C/C = (f/f_r)^2$. The resonant frequency, f_r , varies from over 400 kHz for a capacitance of 1 μ F to 27 MHz for a capacitance of 150 pF when connections are made to the front terminals. f_r is about 300 kHz and 70 MHz for rear connections and the same capacitance.

Max Operating Temperature: 65 $^{\circ}$ C.

Dielectric Absorption: (Voltage Recovery): 0.1% max.

Dissipation Factor: 150 to 1000 pF, 0.001 max, at 1 kHz; over 1000 pF, 0.0002 max, at 1 kHz.

Insulation Resistance: $10^{12} \Omega$ min.

Max Voltage: 500V peak, up to 35 kHz.

Terminals: Four binding posts with grounding link are provided on the front panel. Two of the binding posts are connected to the case and located for convenient use with patch cords in 3-terminal applications. Access is also provided to rear terminals for relay-rack application.

Mechanical: Lab-bench cabinet; brackets provided for rack mount.

Dimensions: 0.89 cm H x 43.9 cm W x 15.3 cm D
(3.5" x 17.25" x 3.5")

Weight: 3.9 kg (8.5 lb.) net, 4.6 kg (10 lb.) shipping.

ORDERING INFORMATION

1412-9410 1412-BC Decade Capacitor



1413 Series

p. 1 of 2

The 1413 is not only a precision standard, it is a systems component as well - connections are made at the rear for this purpose.



Model 1413 Decade Capacitor

- A laboratory standard
- For calibrating working standards
- Standard for dissipation factor
- Verification & calibration of LCR meters
- Working standard
- Capacitance measurement functions
- Verification of calibration of multimeters
- For calibrating instrumentation
- 0 to $>1\mu\text{F}$
- 0.05% basic accuracy
- 6-digit resolution
- 3-terminal connections

Six precision decades are employed to provide a range of 0 to $1.11111\mu\text{F}$ in increments as small as 1 pF and with an accuracy of $0.05\% + 0.5\text{ pF}$. Air capacitors are used for the two lower decades and precision silvered-mica capacitors are used for the remainder. The lower four decades contain adjustments that are factory set but accessible for readjustment later if desired.

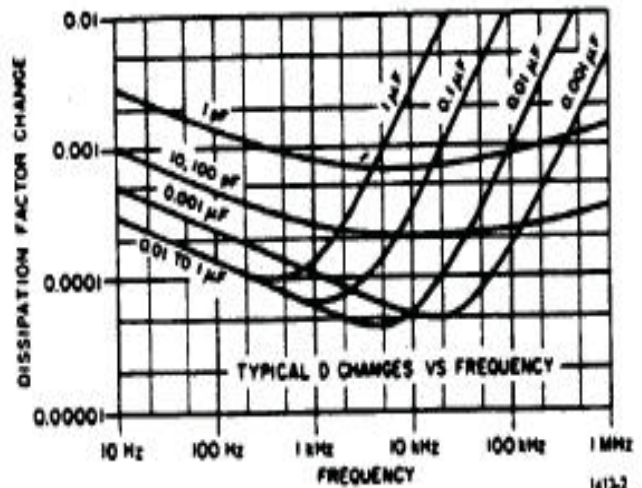
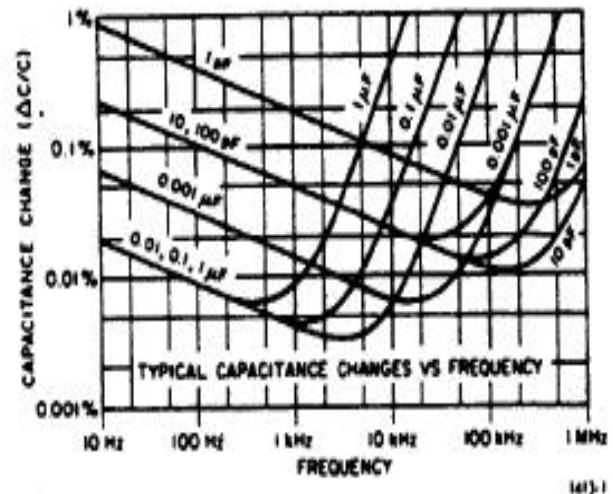

The shielding is divided into two parts arranged to provide low terminal-to-guard capacitance. When the two shields are connected together, the 1413 becomes a well-shielded three-terminal capacitor with an extremely low zero capacitance, suitable for variety of applications



1413 Series

p. 2 of 2

SPECIFICATIONS

Range: 0 to 1.111 11 μ F, controlled by six in-line-readout dials

Accuracy: $\pm(0.05\% + 0.5 \text{ pF})$ at 1 kHz

Stability: $\pm(0.01\% + 0.1 \text{ pF})$ per year.

Frequency: See Figure 1.

Temperature Coefficient: Approx. 20 ppm/ $^{\circ}$ C from 10 to 50 $^{\circ}$ C

Zero Capacitance: <0.1 pF.

Voltage Rating: 500 V pk max up to 10 kHz.

	1 pF to 100 pF	101 pF to 1000 pF	1001 pF to 2000 pF	2001 pF to 0.1 μ F	0.1 μ F to 1.11111 μ F
Dissipation Factor: Max at 1 kHz	0.002	0.001	0.0005	0.0003	0.0004
Insulation Resistance: 3 term., after 2 min at 500V dc	$\geq 5 \times 10^{10} \Omega$				$\geq 5 \times 10^9 \Omega$
Terminal Capacitance: Max high to case	4 pF	8 pF	10 pF	30 pF	60 pF
high to guard	85 pF	110 pF	125 pF	165 pF	200 pF
low to guard	45 pF	70 pF	80 pF	110 pF	120 pF

Interface: Connections: 2 rear-mounted G874 locking connectors.

Mechanical: Convertible-bench cabinet;

Dimensions: 14.2 cm H x 42.3 cm W x 30.4 cm D

(5.59" x 17" x 11.96")

cm W x 27.7 cm D (5.22" x 19" x 10.9")

Rack, 13.3 cm H x 48.3

Weight: Bench, 11 kg (23 lb.) net, 14 kg (29 lb.) shipping

ORDERING INFORMATION

1413-9700	1413	Precision Decade Capacitor Bench
1413-9701	1413	Precision Decade Capacitor Rack Model



1417 Series

p. 1 of 2

The 1417 Four-Terminal Capacitance Standard consists of a 1 μF standard capacitor and two precise inductive voltage dividers used to scale the value of the 1 μF capacitor up to 1 F in decade steps. This arrangement provides accuracy and stability unattainable with very high-value true capacitors.

- A laboratory standard
- Standard for dissipation factor
- Verification & calibration of LCR meters
- Working standard
- Verification of calibration of multimeters
- Capacitance measurement functions
- For calibrating instrumentation
- 1 μF to 1 F in decade steps

In addition to the seven direct-reading capacitance values, an infinite number of intermediate or higher capacitance values can be obtained by using external capacitors. An external capacitor is simply connected to the 1417's external standard terminals, either directly or in parallel with a 1 μF internal standard, and the resulting capacitance is scaled in value by the 1417's inductive voltage dividers.

The direct - reading accuracy of the 1417 is $\pm 0.25\%$ plus ratio accuracy at test frequencies of 100, 120, or 1000 Hz. Since the 1417 scaling ratios are precise and repeatable, better accuracy can be obtained by measuring the actual value of the internal 1 μF standard or of an external standard before scaling.

The 1417 also serves as a standard of dissipation factor (D). The dissipation factor of the 1417 is intentionally set to 0.01 at test frequencies of 100, 120 and 1000 Hz. Basic D accuracy at these frequencies is ± 0.001 .

The 1417 may also be used as a two-terminal capacitance standard when higher D values can be tolerated. In a two-terminal configuration, D is less than 1 for capacitance values up to 1000 μF at frequencies below 150 Hz. This feature allows the 1417 to be used in calibrating the higher capacitance ranges of popular universal or RLC bridges.

One additional feature of importance is that all the 1417's parameters are measurable (without) disassembly so, in effect, its ultimate accuracy depends on the accuracy of the external measurement equipment.



Model 1417 Capacitance Standard

- 0.25% direct-reading capacitance accuracy
- 0.1% or better ratio accuracy
- Dissipation - factor standard

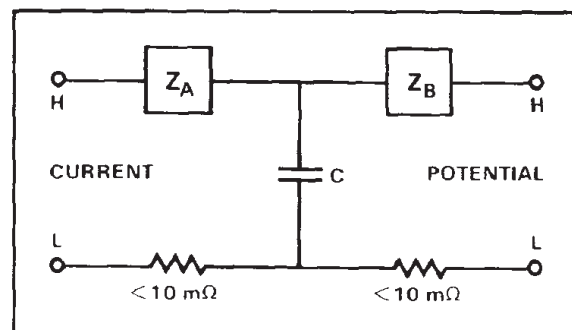
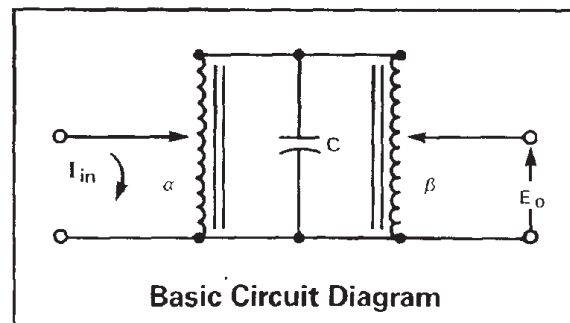

1417 Series

p. 2 of 2

SPECIFICATIONS

Capacitance Value (Internal Standard)	Ratio Accuracy		D Accuracy		Approximate Terminal Impedance		E Max* AC (V) *DC Voltage cannot be applied
	100 & 120 Hz	1 kHz	100 & 120 Hz	1 kHz	ZA (Ω)	ZB (Ω)	
1 μF	-----	-----	± 0.001	± 0.001	0.03	0.03	20
10 μF	0.02%	0.04%	± 0.001	± 0.001	7.0	15.5	6
100 μF	0.02%	0.04%	± 0.001	± 0.001	3.1	6.4	2
1 mF	0.02%	0.06%	± 0.001	± 0.002	1.1	2.2	0.8
10 mF	0.03%	0.2%	± 0.001	± 0.005	0.37	0.72	0.5
100 mF	0.1%	-----	± 0.003	-----	0.13	0.23	0.25
1 F	0.25%	-----	± 0.01	-----	0.04	0.05	0.06

Capacitance:

Internal Standard: 1 μF in 7-switch-selected decade values
External Standard: Indicated capacitance, multiplied by C ext/ μF .

Capacitance Accuracy, Direct-Reading: 0.25% plus ratio accuracy at 100 Hz, 120 Hz and 1 kHz, 20 to 25°C, with low applied voltage ($< \frac{1}{4} E$, max) using internal standard and a proper four-terminal measurement. (May also be used as a two-terminal standard, with a $D < 1$ and a capacitance change from the four-terminal value of $< \frac{1}{2} \%$ up to 1 mF at 120 Hz or less).

Capacitance Ratio: Accuracy see table above.

Dissipation Factor: 0.01 at 100 Hz, 120 Hz and 1 kHz. For D accuracy, see table.

Terminal Impedance: See figure and table (approximate values given).

Temperature Coefficient: Approximately -140ppm/°C.

Voltage Characteristic: Approximately +0.3 % change from 0_V to E max (see table) at 100 Hz. Less at higher frequencies.

Mechanical: Bench cabinet.

Dimensions: 14.7 cm H x 21.5 cm W x 13.2 cm D
(5.9" x 8.5" x 5.25").

Weight: 52.7 kg (6 lb.) net, 5 kg (11 lb.) shipping.

ORDERING INFORMATION

1417-9700 Four-Terminal Capacitance Standard



1422 Series

p. 1 of 2

The 1422 is a stable and precise variable air capacitor intended for use as a continuously adjustable standard of capacitance. One of the most important applications is an AC bridge measurements, either as a built-in standard for substitution measurements. It is available in a variety of ranges, terminal configurations, and scale arrangements to permit selection of precisely the required characteristics.

- A laboratory standard
- For calibrating working standards
- Working standard
- Capacitance measurement functions
- For substitution measurements
- For calibrating instrumentation
- Stability: better than 0.02% full scale per year
- Settleeable to 40 ppm

Two-terminal - The 1422-D is a dial-range, two-terminal capacitor, direct reading in total capacitance at the terminals.

Three-terminal - The 1422-CB and -CL are three-terminal capacitors with shielded coaxial terminals for use in three-terminal measurements. The calibrated direct capacitance is independent of terminal capacitance to ground, and losses are very low. The 1422-CL has particularly low, constant terminal capacitance, making it suitable for measurement circuits in which high capacitance to guard cannot be tolerated.

Construction - The capacitor assembly is mounted in a cast frame for rigidity. This frame and other critical parts are made of aluminum alloy selected to give the strength of brass with the lightness of aluminum. The plates of most models are also aluminum, so that all parts have the same temperature coefficient of linear expansion.

A worm drive is used to obtain high precision of setting. To avoid eccentricity, the shaft and the worm are accurately machined as one piece. The worm and worm wheel are also lapped into each other to improve smoothness. The dial end of the worm shaft runs in a self-aligning ball bearing, while the other end is supported by an adjustable spring mounting, which gives positive longitudinal anchoring to the worm shaft through the use of a pair sealed, self-lubricating, preloaded ball bearings. Similar pairs of preloaded ball bearings provide positive and invariant axial location for the main or rotor shaft. Electrical connection to the rotor is made by means of a silver-alloy brush bearing on a silver-overlay drum to assure a low-noise electrical contact.

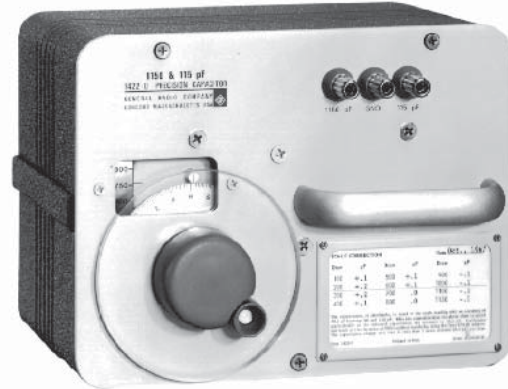

Model 1422 Precision Capacitor

- Low temperature coefficient, low losses
- Wide selection to suit needs
- 3 different models

Stator insulation in all models is a cross-linked thermosetting modified polystyrene having low dielectric losses and very high insulation resistance. Rotor insulation, where used (Types 1422-CB and -CL), is in grade L-4 steatite, silicone treated.

Accuracy - The errors tabulated in the specifications are possible errors, i.e., the sum of error contributions from setting, adjustment, calibration, interpolation, and standards. When the capacitor is in its normal position with the panel horizontal, the actual errors are almost always smaller. The accuracy is improved when the readings are corrected using the 12 calibrated values of capacitance given on the correction chart on the capacitor panel and interpolating linearly between calibrated points. Even better accuracy can be obtained from a precision calibration of approximately 100 points on the capacitor dial, which permits correction for slight residual eccentricities of the worm drive and requires interpolation over only short intervals. This precision calibration is available for the 1422-CL model. A plastic-enclosed certificate of calibration is supplied, giving corrections to one more figure than the tabulated accuracy.

1422 Series

p. 2 of 2

SPECIFICATIONS

Accuracy:	1422 Precision Capacitors Type 1422	Two-terminal Type 1422-D	Three-terminal Type 1422-CB	Three-terminal Type 1422-CL
Capacitance Range (Min/Max)		100/1150 pF 35/115 pF	50/1100 pF	10/110 pF
Scale, pF/Division		0.2 0.2	0.2	0.02
Initial Accuracy: Picofarads Direct-Reading (Adjustment): Total Capacitance		1.5* 0.3*	1.5	0.1
With Corrections from Calibration Chart (supplied) Total Capacitance				0.04
With Corrections from Precision Calibration (extra charge) Total Capacitance				0.01
Residuals (typical values): Series Inductance, μH Series Resistance, Ω at 1 MHz		0.06 0.10 0.04 0.05	0.14 0.1	0.13 0.1
Terminal Capacitance, pF, typical high terminal to case low terminal to case		min/max scale min/max scale	36/35 58/53	34/33 58/55
* Total capacitance is the capacitance added when the capacitor is plugged into a 777-Q3 Adapter				

Stability: Capacitance change with time < 1 scale division (0.02% of full scale) per year

Long-term accuracy can be estimated from the stability and the initial accuracy.

Calibration: Measured values (supplied) are obtained by comparison at 1 kHz, with working standards whose absolute values are known to and accuracy of $\pm (0.01\% + 0.0001 \text{ pF})$. Each comparison is made to a precision better than $\pm 0.01\%$. The values of the working standards are determined and maintained in terms of reference standards periodically calibrated by the National Institute of Standards and Technology. The indicated value of total capacitance of a two-terminal capacitor is the capacitance added when 1422 Capacitor is plugged into a 777-Q3 Adapter *. The uncertainty of this method to connection is approximate $\pm 0.03 \text{ pF}$.

* Gilbert Engineering Part Number 0777-9703.

Insulation Resistance: $> 10^{12} \Omega$, under standard conditions (23°C, RH < 50%).

Maximum Voltage: 1000 V pk (all models)

Terminals: 2-terminal Model: Jack-top binding posts at standard (0.75 in) spacing. Rotor terminal connected to panel and shield.
3-terminal Models: Locking G874 coaxial connectors.

Mechanical: Lab-bench cabinet.

Dimensions: 17.8 cm H x 24.2 cm W x 21.5 cm D
(7" x 9.5" x 8.5").

Weight: (depending on model): 4.8 to 5.7 kg (10.5 to 12.5 lb.) net, 7 kg (15 lb.) shipping.

Resolution: Dial can be read and set to 1/5 of a small division, i.e. to 0.004% of full scale. BACKLASH: Negligible for any setting reached consistently from lower scale readings; <0.004% of full scale, for settings reached from alternate directions.

Temperature Coefficient: Approximately +20 ppm/°C, for small temperature changes.

Residual Parameters: See table above. Series resistance varies as \sqrt{f} for $f > 100 \text{ kHz}$; negligible, for $f < 100 \text{ kHz}$.

Frequency Characteristic: 2-terminal model, see Figure 1. 3-terminal models: 20 and 40 MHz (approximately) resonant frequency for 1422-CB and -CL (each section), respectively.

Dissipation Factor: 2-terminal, loss primarily in stator supports of low-loss polystyrene (the product $DC = 10^{-14}$), 3-terminal, estimated $D < 20 \times 10^{-6}$.

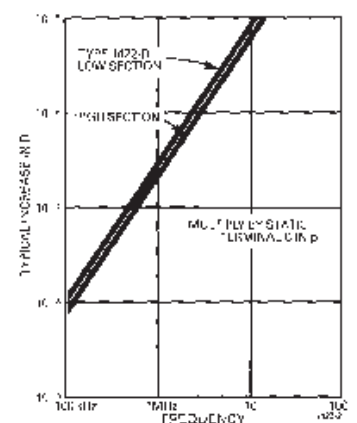
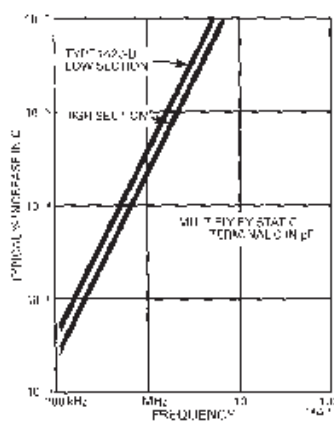

ORDERING INFORMATION

Catalog No:	Item	Name	Calibration
1422-9704	1422-D	Precision Capacitor	12 points
1422-9916	1422-CB	Precision Capacitor	12 points
1422-9933	1422-CL	Precision Capacitor	12 points
1422-9508	1422-CLP	Precision Capacitor	~100



IET LABS, INC. in the **GenRad** Tradition
534 Main Street, Westbury, NY 11590
Electronic cat/1422 p2/02-26-06

www.ietlabs.com
TEL: (516) 334-5959 • (800) 899-8438 • FAX: (516) 334-5988

GenRad 1433 Series

p. 1 of 2

The 1433 Decade Resistors are primarily intended for precision measurement applications where their excellent accuracy, stability, and low zero resistance are important. They are convenient resistance standards for checking the accuracy of resistance measuring devices and are used as components in dc and audio frequency impedance bridges. Many of the models can be used into the radio-frequency range.



Model 1433 Precision Decade Resistor

- Resistance range from 1 mΩ to 111 MΩ
- High accuracy - 0.01% up to 10 MΩ steps.
- Low temperature coefficient
- Good frequency characteristics
- Excellent stability
- Low zero resistance
- May be used for RTD simulation
- Rack mount option

There is a large selection of models available, with 3 through 11 decades, covering a wide resistance range from 1 mΩ to over 111 MΩ. Each 1433 is an assembly of multiple long-contact-life switches and precision resistors in a single cabinet. The individual switches have solid silver contacts. The dials, labeled 0 to X (=10), offer continuous rotation from position to position with no stops. Each dial also has an overlap 10 position to eliminate the need of having to reset all dials when passing through a decade point. The resistance per step and maximum current of each dial is clearly shown on the front panel. Electrical shielding is provided by an attractive aluminum cabinet and front panel. The resistance elements have no electrical connection to the cabinet and panel; a separate shield terminal is provided.

Figure 1: Typical Frequency Characteristics

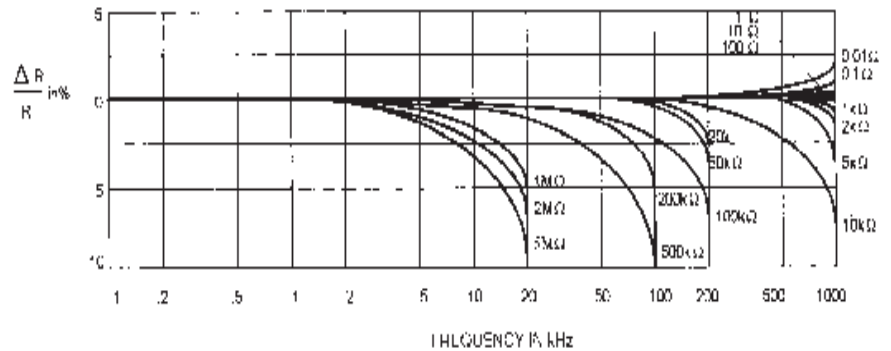

SPECIFICATIONS

Over-all Accuracy: The difference between the resistance at any setting and at the zero setting is equal to the indicated value ± (0.01% + 2 mΩ). (±0.03% for 10 MΩ steps.)

Resistance per Step	Total Decade Resistance	Stability (±ppm/year)	Long Term Stability (±ppm/3 years)	Temperature Coefficient (±ppm/°C)	Max. Power (W/step)	Maximum current (per decade)	Maximum voltage (per step)
1 mΩ	10 mΩ	100	700	50	0.025	5 A	5 mV
10 mΩ	100 mΩ	50	350	20	0.2	4 A	40 mV
100 mΩ	1 Ω	30	50	20	0.25	1.6 A	0.16 V
1 Ω	10 Ω	10	25	20	0.6	0.8 A	0.8 V
10 Ω	100 Ω	10	25	15	0.6	0.25 A	2.5 V
100 Ω	1 kΩ	10	25	5	0.6	80 mA	8 V
1 kΩ	10 kΩ	10	25	5	0.5	23 mA	23 V
10 kΩ	100 kΩ	10	25	5	0.5	7 mA	70 V
100 kΩ	1 MΩ	10	25	5	0.5*	2.3* mA	230 V*
1 MΩ	10 MΩ	10	25	10	0.5*	0.7* mA	700 V*
10 MΩ	100 MΩ	25	40	10	0.1*	0.1* mA	1000 V*

* Subject to maximum of 2000 V.



GenRad 1433 Series

p. 2 of 2

SPECIFICATIONS

Typical Frequency Characteristics: See Figure 1.

Typical Values of R_0 , L_0 and C for the Decade Resistors:
Zero Resistance (R_0): 0.001 Ω /decade at dc (higher for 7-10 decades);
0.04 Ω /dial at 1 MHz; proportional to the square root of frequency
above 100 kHz. Zero Inductance (L_0): 0.1 μ H/dial + 0.2 μ H

Effective Shunt Capacitance (C): Value is determined largely by the highest decade in use. With the low terminal connected to the shield, a value of 15 to 20 pF/decade may be assumed, counting decades down from the highest. Thus, if the third decade from the top is the highest resistance, a value of 45 to 60 pF may be assumed. If the highest decade in the unit is in use, the effective capacitance is 15 to 20 pF, regardless of the settings of the lower resistance decades.

Temperature Coefficient of Resistance:

<10 ppm/ $^{\circ}$ C for 100 Ω and over;
+20 ppm/ $^{\circ}$ C for 10 Ω and under;
at room temperatures.

Assembly will increase the over-all temperature coefficient of the 0.1 and 0.01 Ω .

Switches: Continuous dial rotation; solid silver contacts; contact resistance of less than 1 m Ω ; capacitance of less than 1 pF between contacts; lifetime in excess of 1 million cycles.

Maximum Voltage to case: 2000 V pk.

Terminals: Gold plated, low thermal-emf jack-top binding posts on standard 3/4" spacing. Shield terminal provided.

Mechanical: Lab-bench cabinet.

Model	Dimensions	Weight
1 decade	7.7 cm W x 7.7 cm H x 8.4 cm D (3" x 3" x 3.3")	0.45 kg (1.0 lb)
2-4 decades	37.5 cm W x 8.9 cm H x 10.2 cm D (14.8" x 3.5" x 4")	1.7 kg (3.8 lb)
5 decades		2.0 kg (4.3 lb)
6 decades	43.9 cm W x 8.9 cm H x 10.2 cm D (17.3" x 3.5" x 4")	2.2 kg (4.8 lb)
7 decades		2.4 kg (5.3 lb)
8 decades		2.6 kg (5.7 lb)
9 decades	48.3 cm W x 17.8 cm H x 19.7 cm D (19.0" x 7.0" x 7.8")	5.1 kg (11.2 lb)
10 decades		5.3 kg (11.7 lb)
11 decades		5.4 kg (11.9 lb)

ORDERING INFORMATION

Catalog No	Total (Ω)	Min step	No of dials
1433-01	1,110	0.001	3
1433-00	111.10	0.01	4
1433-02	1,111.0	0.1	4
1433-04	11,110	1	4
1433-06	111,100	10	4
1433-08	1,111,000	100	4
1433-09	11,110,000	1000	4
1433-09A	111,100,000	10,000	4
1433-10	1,111.10	0.01	5
1433-10A	111.110	0.001	5
1433-12	11,111.0	0.1	5
1433-14	111,110	1	5
1433-16	1,111,100	10	5
1433-18	11,111,000	100	5
1433-18A	111,110,000	1000	5
1433-19	1,111.110	0.001	6
1433-20	11,111.10	0.01	6
1433-22	111,111.0	0.1	6
1433-24	1,111,110	1	6
1433-26	11,111,100	10	6
1433-27	111,111,000	100	6
1433-28	11,111.110	0.001	7
1433-29	111,111.10	0.01	7
1433-31	1,111,111	0.1	7
1433-33	11,111,110	1	7
1433-34	111,111,100	10	7
1433-35	111,111.110	0.001	8
1433-36	1,111,111.10	.01	8
1433-37	11,111,111.0	0.1	8
1433-38	111,111,110	1	8
1433-39	1,111,111.110	0.001	9
1433-39A	11,111,111.10	0.01	9
1433-39B	111,111,111.0	0.1	9
1433-40A	11,111,111.110	0.001	10
1433-40	111,111,111.10	0.01	10

INCLUDES:

- Calibration Certificate Traceable to SI

OPTIONAL ACCESSORIES:

- Calibration Data
- 1433-50 Rack Mount Kit (4 dial)
- 1433-51 Rack Mount Kit (5 dial)
- 1433-52 Rack Mount Kit (6 dial)
- 1433-53 Rack Mount Kit (7 dial)



1565-B Series

The 1565-B a general purpose sound-level meter, ideal for measurements required by OSHA and for general noise surveys. This popular meter weights less than 1 pound, features simple pushbutton operation, battery power, and a rigged ceramic microphone. The 1565-B may be purchased alone, with an acoustic calibrator, windscreen, and with a choice of carrying/storage cases.

- 40 to 140 dB
- ANSI Type 2
- A, B, C weighting
- Fast/slow meter response
- MESA approved



Model 1565-B Sound-Level Meter

SPECIFICATIONS

Sound Level: 40 to 140 dB re 20 $\mu\text{N}/\text{m}^2$

Weighting: A, B, and C. Conforms to ANSI S1, 4-1971 Type 2 and IEC651.

Meter: rms response with fast and slow speeds.

Input: MICROPHONE: Lead-ziconate-titanate ceramic.

Output: > 1.2 Vrms behind 620 Ω with meter at full scale; will drive oscilloscope or low-impedance headphones. HARMONIC DISTORTION: < 0.5% (0.1% typical) from 32 Hz to 8 kHz, C-weighted with meter at full scale. Any load impedance may be connected.

Calibration: Can be pressure calibrated at 125, 250, 500, 1000, and 2000 Hz with GR 1562 Calibrator, and at 1000 Hz with GR 1987*.

Environmental: TEMPERATURE: -10 to 50°C operating: -40 to +60°C storage, with batteries removed; coefficient of sensitivity ~ +0.02 dB/°C at 6 dB below full-scale meter reading. HUMIDITY: 0-90% RH within 0.5 dB. MAGNETIC FIELD: 1 oersted (80 A/m) 50- or 60- Hz field causes about 45 dB C-weighted (negligible A-weighted) indication when meter is oriented for maximum sensitivity to field. A

1-oersted, 400-Hz field causes about 58 db A-wwighted indication when meter is oriented for maximum sensitivity. VIBRATION: With the microphone attached, the highest meter indications (without interference from background noise) when the instrument is vibrated at an acceleration of 0.1 g, are 67 dBA at 63 Hz, 68 dBA at 250 Hz, and 70 dBA at 1000 Hz. When the microphone is replaced by an equivalent impedance, the same test gives no meter indication.

Supplied: Microphone safety cap, instruction manual, carrying case.

Power: Two 9V alkaline batteries (NEDA 1604AC) supplied, provide 50 hours of operation.

Mechanical: Shielded plastic case

Dimensions: 16.5 cm H x 0.92 cm W x 0.53 cm D (6.5" x 3.63" x 2.09").

Weight: 0.48 kg (13 oz) net, 1.4 kg (3 lb) shipping.

* At 125, 250, 500, 1000, 2000, and 4000 Hz with GR 1986 Calibrator.

ORDERING INFORMATION

1565-9702 1565-B Sound-Level Meter

1562-9600 Carrying Case



1562-A Series

- Workhorse of the acoustics field
- Calibrates most sound-level meters
- Generates standard level and frequencies
- Adaptable to various microphone sizes
- Use in the lab or in the field
- Supplied with instruction Manual and batteries
- Adaptors and cases available



Model 1562-A Sound-Level Calibrator

SPECIFICATIONS

Acoustical Output:

Frequencies: 125, 250, 500, 1000 and 200 Hz

Frequencies Accuracy: $\pm 3\%$

Output Level: 114 dB re $20 \times 10^{-6} \mu\text{N}/\text{m}^2$

Level Accuracy: at 23°C and 790 mm Hg:
 ± 0.3 dB @ 500 Hz;
 ± 0.5 dB @ other frequencies.

Adaptors: Fits GenRad 1 1/8" mics directly;
other mics require adaptors
(available in limited quantities).

Output Voltage: 1.0 V $\pm 20\%$ behind 6000 Ω .

Frequency Characteristic: Output is flat $\pm 2\%$.

Distortion: $< 0.5\%$.

Connector: Jack to accept standard 1/4" phone plug.

Power Requirements: standard 9 V alkaline battery
(NEDA 1604 AC).

Dimensions: 12.4 cm H x 5.7 cm W (4.9" x 2.2").

Weight: 0.45 kg (1 lb).

Operating Environment: 0 to 40°C, 0 to 95% relative humidity.

Storage Temperature: -40 to +60°C with battery removed.

ORDERING INFORMATION

1562-A Sound-Level Calibrator



1531-AB and 1538-A Strobotac® Series

p. 1

Strobotac provides two high quality models to choose from to fulfill your electronic stroboscopic needs. The 1531-AB for most applications and the 1538-A for situations requiring very high flash rates. Both instruments offer proven reliability.

- For machine maintenance
- Real time inspection of moving parts
- Printing press applications
- Motor troubleshooting
- For stopping motion
- MODEL 1531-AB:
 - Flash rates up to 25,000 fpm with accuracy of +1.0%
 - Unique, rugged carrying case for portability
 - Flash duration ranging from 0.8 μ s to 3.0 μ s for clear, crisp images

Compact and accurate. These strobes are small portable flashing-light sources used to measure the speed of fast-moving devices or to produce the optical effect of stopping or slowing high-speed motion for observation. A build-in system uses the power-line frequency for quick and easy checks and adjustment of the flash-rate calibration. Each flash lamp/reflector assembly is hinged at the panel and the reflector swivels 360 degrees, for complete flexibility. The cases have standard sockets (0.25 x 20 threads/inch) for tripod mounting.

Model 1531-AB and
1538-A Strobes



- MODEL 1538-A:
 - High speed, adjustable flash rates up to 150,000 fpm provide direct reading in four ranges with $\pm 1.0\%$ accuracy
 - Flash duration from 0.5 μ s to 3.0 μ s for clear, crisp images
 - Unique, rugged carrying case for portability
 - Can be battery operated

Versatile synchronization: A variety of trigger inputs can be used for flash synchronization. Contact closures, pulses, or sinewave signals will trigger the flash, and an output trigger is provided so the stroboscope, in turn, can trigger another device. Single-flash photographs of high-speed motion are a snap with any still camera.

The difference: The 1531 is more economical to buy. On the other hand, the 1538 gives you six times the maximum flash rate of the former, and enable portable operation with a rechargeable battery. The 1538-A can also be used with an optical extension lamp.

* 1538-P2 Extension Lamp;
accessory for the 1538-A



1531-AB and 1538-A Strobotac® Series

p. 2 of 2

SPECIFICATIONS

SERIES 1531-AB:

Flash Rate: 110 to 25,000fpm in 3 ranges; speeds up to 250,000rpm can be measured.
 Accuracy: ±1% of reading after calibration on one range against 50-to-60Hz line frequency.
 External Trigger: Input and output connections are phone jacks.
 Input: Contact opening, pulse ≥ +6V pk-pk, or sinewave ≥ 2V rms for f>5Hz.
 Output: Negative pulse ≥ 500 to 1000V.
 Light Output: Beam width 10° degrees at ½-intensity points.

SERIES 1538-A:

Flash Rate: 110 to 150,000fpm in 4 ranges; speeds up to 1,000,000 rpm can be measured.
 Accuracy: 1% of reading after calibration on 670-to-4170fpm range against 50-to-60Hz line frequency.
 External Trigger: Input and output connections are phone jacks.
 Input: Contact closure, pulse ≥ +1V pk-pk, or sinewave ≥ 0.35V rms for f>5Hz (3.5V at 10Hz)
 Output: ≥ +6V behind 400 Ω.
 Light Output: Beam width 10° at ½-intensity points.

Flashes per minute	Duration* (µs)	Energy** (watt-seconds)	Beam intensity*** (candela)
at 690	3	0.5	11 x 10 ⁶
at 4170	12	0.09	3.5 x 10 ⁶
at 25,000	0.8	0.014	0.6 x 10 ⁶

Flashes per minute	Duration* (µs)	Energy** (watt-seconds)	Beam intensity*** (candela)
at 690	3	0.5	15 x 10 ⁶
at 4170	1.2	0.09	5 x 10 ⁶
at 25,000	0.8	0.014	1 x 10 ⁶
at 150,000	0.5	0.0023	0.16 x 10 ⁶

* Measured at 1/3 peak intensity.

** Electrical input to lamp.

*** Measured with silicon photo detector 1 meter from lamp; single-flash beam intensity is 18 x 10⁶ candela

* Measured at 1/3 peak intensity.

** Electrical input to lamp.

*** Measured with silicon photo detector 1 meter from lamp; single-flash beam intensity with - P4 is 44 x 10⁶ candela

Features

Power: 100 to 125 V, or 200 to 250 V, 50 to 400 Hz, 25 W max for 1531, 15 W max for 1538; 1538 can also be powered from 20 to 30 V DC, 12 W max.

Mechanical: Flip-Tilt Case.

Dimensions: 16.8 cm H x 27.0 cm W x 15.6 cm D (6.63" x 10.63" x 13")

Weight: 3.5 kg (7.5 lb.) net, 4.6 kg (10 lb.) shipping

ORDERING INFORMATION

Catalog Number	Item	Voltage Model (V)
1531-9430	1531-AB	115
1531-9440	1531-AB	230
1538-9701	1538-A	115
1538-9702	1538-A	230

INCLUDES:
 Calibration Certificate Traceable to NIST
 Adjustable Neck Strap
 Phone plug for input and output jacks
 Power Cord

OPTIONS

Calibration Data

1538-9601 1538-P1 Replacement Strobotron Flash Lamp, for 1531/1538

Accessories for 1538-A only:

1538-9602 1538-P2 Extension Lamp

1538-9603 1538-P3 Battery and Charger

1538-9604 High Intensity -Flash Capacitor; increases output



1539-A Strobotac® Series

The 1539-A is a cost effective solution when external triggering only is required or when high intensity light is necessary by using multiple units.

- For machine maintenance
- Real time inspection of moving parts
- Printing press applications
- Motor troubleshooting
- For stopping motion
- Externally triggered flash rate up to 25,000 frm
- Detachable lamp for easy observation of objects in hard-to-reach areas
- Versatile delayed triggering from 100μ to 800 ms with Strobotac Flash Delay accessory

Slaved light-the 1539-A.

The Stroboslave stroboscope light source satisfies the basic requirements for motion studies and high-speed photography-it produces a bright white light at flash rates up to 25,000 per minute. Since it contains no internal oscillator to establish the flash rate, it is an economical unit and is well suited for use with external inputs.



Model 1539-A StroboSlave

- Low cost, compact
- High-intensity light

The lamp and reflector assembly is held in place by a clip from which it can be easily removed and positioned separately from the main unit. A five-foot flexible cable is supplied and cables up to 50 feet can be used. When the reflector is removed from the assembly, the lamp can be inserted through holes as small as one inch in diameter, thus making it possible to observe objects in otherwise inaccessible areas.



A tripod socket is provided on the Stroboslave case.



The lamp can be removed from its clamp at end of case and hand-held up to 5 feet away.

Series 1539-A Stroboscopic Light Source

SPECIFICATIONS

Flash Rate: 0 to 25,000 flashes per minute, externally triggered only

Light Output: Beam width 10° at ½ - intensity points.

Flashes per minute	Duration* (µs)	Energy** (watt-seconds)	Beam intensity*** (candela)
at 700	3	0.5	11×10^6
at 4200	12	0.09	3.5×10^6
at 25,000	0.8	0.014	0.6×10^6

* Measured at 1/3 peak intensity; for 1538 with -P4 duration is 8 µs.

** Electrical input to lamp, watt-seconds.

*** Measured with silicon photo detector 1 meter from lamp; single-flash beam intensity is 18×10^6 candela.

Features

External Trigger: Contact closure or pulse of ±2 V pk applied to phone jack.

Power: 100 to 125 V, or 195 to 250 V, 50 to 400 Hz, 16 W max.

Mechanical: Metal case with detachable lamp housing.

Dimensions: 21.3 cm H x 6.4 cm W x 10.5 cm D (8.38" x 2.5" x 4.13")

Weight: 1.4 kg (3 lb.) net, 3.7 kg (8 lb.) shipping

ORDERING INFORMATION

1539-9701 1539-A Strobotac Light Source

INCLUDES:

Calibration Certificate Traceable to NIST
Mounting Bracket
Phone plug for input and output jacks
Attached Power Cord

OPTIONAL ACCESSORIES:

Calibration Data
1538-9601 1538-P1 Replacement Strobotron Flash Lamp



1542-B Strobotac® Stroboscope Series

The 1542-B is an extremely easy to use and low cost solution for Strobe-Inspection operations. It is ideal for timing and observing motion in a variety of situations.

- For machine maintenance
- Real time inspection of moving parts
- Printing press applications
- Motor troubleshooting
- For stopping motion
- Up to 3800 bright-white flashes per minute -to observe motion as fast as 40,000 rpm
- Wide-range continuous flash-rate control
- Low-cost, excellent OEM strobe

The Strobotac 1542-B has been tailored for convenient operation. This strobe was designed specifically for inspection applications and features simple pushbutton control with a single knob to control the flash rate - no range switching is ever necessary. This strobe includes a unique electronically compensated output for visually constant image brightness (as the flash rate decreases, the light intensity hand-held operation and includes a threaded hole for tripod mounting.

All components are industrial grade and the engineering is completely thorough, including exacting environmental testing to ensure reliable operation under extreme conditions.



Model 1542-B Stroboscope

- Simple push-button operation
- Compact, light-weight, rugged

The 1542-B - simple, economical. The 1542-B is as easy to operate as an extension lamp but is considerably more useful. Plug in the attached power cord, push the On-Off button, point the light at the action, and turn one knob until the visual image of the action slows to the desired rate or stops. That's the sum total of the operation - plug, push, point, and turn!



The arm is available as an accessory to position the light conveniently in permanent or semi-permanent installations.



Convenient hand held or optional fixed position operation.

Series 1542-B Electronic Stroboscope

SPECIFICATIONS

Flash Rate: 180 to 3,800 flashes per minute, adjustable over a single range by a 5-turn uncalibrated control.

External Trigger: None.

Trigger Delay: None.

Light Output: Beam width 10° at ½ - intensity points.

Flashes per minute	Duration* (μs)	Energy** (watt-seconds)	Beam intensity*** (candela)
at 180	4	0.25	6 x 10 ⁶
at 3800	3	0.06	1 x 10 ⁶

* Measured at 1/3 peak intensity; for 1538 with -P4 duration is 8 μs.

** Electrical input to lamp, watt-seconds.

*** Measured with silicon photo detector 1 meter from lamp.

Features

Environment: Temperature: 0 to 50°C operating, -40° to +75°C storage.

Humidity: 95% RH at +40°C (MIL E-16400-44.5.4.6).

Vibration: 0.03 in from 10 to 55 Hz.

Bench Handling: 4 in or 45° (MIL-810AVI).

Shock: 50 g, 11 ms (MIL 202C-205C).

Power: 105 to 125 V, 50 to 60 Hz, 9 W max.

Mechanical: Molded plastic case with plastic face plate to protect lamp, diffused-finish and anodized-aluminum reflector, standard 0.25 - 20 threaded hole for tipod mounting.

Dimensions: 10.7 cm H x 10.7 cm W x 19.8 cm D (4.2" x 4.2" x 7.8")

Weight: 0.8 kg (1.8 lb.) net, 0.9 kg (2.1 lb.) shipping

ORDERING INFORMATION

1542-9701 1542-B Strobotac Electronic Stroboscope

INCLUDES:

Calibration Certificate Traceable to NIST
Attached Power Cord

OPTIONAL ACCESSORIES:

Calibration Data
1530-9410 Replacement Flash Lamp for 1542-B
1542-9600 Arm, for 1542-B, to position light conveniently in permanent or semi-permanent installations



1546 Strobotac® Series

The 1546 Strobotac Digital Stroboscope features a large, five-digit LED readout that automatically displays the flash rate in bold, easy-to-read digits. This display eliminates the need to calibrate and read a dial to obtain accurate speed measurements.



Model 1546-B Digital Stroboscope

- For machine maintenance
- Real time inspection of moving parts
- Printing press applications
- Motor troubleshooting
- For stopping motion
- Quartz crystal accuracy of $\pm 0.01\%$ for speed,

Encased in a rugged, high-impact housing, the 1546 is designed for maximum portability. Its light-weight design (just 2.65 pounds) promotes hand-held operation and permit access to hard-to-light areas under inspection. The strobe also may be operated from any flat surface or mounted on a tripod.

The 1546 emits a high intensity, short duration flash of light for crisp, clear images of fast moving objects. It has a broad flash frequency range from 100 to 25,000 flashes per minute.

The 1546 is capable of both internally and externally triggered modes of operation. In the internal mode, the flash is triggered by an internal oscillator pulse that can also drive other Strobotac stroboscopes for additional light sources. In the external mode, the 1546 operates as a digital tachometer when a voltage pulse or

turns, or rpm measurements

- Large five-digit LED readout for instant, accurate readings
- Flash rates ranging from 100 to 25,000 fpm in three ranges
- Input connector for external triggering

contact closure is activated by the rotation of an object.

The unit is particularly suited to speed measurements because of the instant digital readout. In machinery design and maintenance applications, the 1546 will help determine the speed of rotating components, slippage between shafts, condition of belts and gears, alignment of couplings, and effect of chassis vibration, all at operating speed. It is very useful for quality control inspection and set-up of process machinery such as bottling, canning, packaging, and stamping operations. Other ideal applications are textile machinery adjustments, printing press registration, electrical equipment design and servicing, photography of high speed events, and physics lab demonstrations.

SPECIFICATIONS

Flash Rate:

100 to 25,000 flashes per minute (fpm) in three overlapping ranges	Range	fpm
	1 Low	100-700
	2 Med	600-4,200
	3 High	3,600-25,000

Flash Duration:

approximate	Range	μ s
	1 Low	2
	2 Med	2
	3 High	1.2

Accuracy: $\pm 0.01\%$, crystal-controlled time base. Display accuracy limited by resolution of display below 10,000 fpm to ± 1 fpm.

Tachometer Function: LED display reads for both internal and external modes.

External Trigger: Three-terminal phone jack, $> + 1.0$ V pulse, > 0.75 rms sine wave, or contact closure.

Trigger Output: > 2.5 V behind 1 k Ω .



Series 1546 Digital Stroboscope

Features

Environment:

Temperature: 0 to 50°C operating, -40°C to + 75°C storage.

Humidity: 95% RH at + 40°C (MIL E-16400-44.5.4.6).

Vibration: 0.03 in DA from 10 to 55 Hz.

Bench Handling: 4 in or 45°C (MIL-810A-VI).

Shock: 30 g, 11 ms.

Power: 105 to 125 V, 50 to 60 Hz, 20 W.

Mechanical: Molded plastic case with plastic face plate to protect lamp, diffused-finish and anodized-aluminum reflector, standard 0.25-20 threaded hole for tripod mounting or handle grip.

Dimensions: 10.952 cm H x 10.795 cm W x 23.495 cm D
(4.312" x 4.25" x 9.25")

Weight: 1.2 kg (2.65 lb.) net, 1.55 kg (3.4 lb.) shipping

ORDERING INFORMATION

1546-9700 1546 Strobotac Digital Electronic Stroboscope

INCLUDES:

Calibration Certificate Traceable to NIST

Phone plug for input and output jacks

Attached Power Cord

OPTIONAL ACCESSORIES:

Calibration Data

1538-9610 Replacement flash lamp for 1546



1620-A High Precision Capacitance Measurements

The 1620-A is a self-contained assembly of the 1615-A Capacitance Bridge with appropriate oscillator and null detector for measurements at 11 frequencies between 50 Hz and 10 kHz. For applications requiring other or higher frequencies, to 100 kHz, the 1615-A Bridge can be supplied separately and the oscillator and detector selected to meet your needs.

- Accurate and precision measurements of capacitance and dissipation factor
- Measurement of circuit capacitances
- Dielectric measurements
- Intercomparison of capacitance standards differing in magnitude by as much as 1000:1
- 10^{-5} pF to 11.1 μ F, 2- or 3- terminal
- 0.01% accuracy, 1 ppm resolution
- Lever balance, in-line readout
- Reads dissipation factor or conductance

The 1615-A Capacitance Bridge brings to the measurement of capacitance, the intercomparison of standard, and to the measurement of dielectric properties an unusual degree of accuracy, precision, range, and convenience.

High accuracy is achieved through the use of precisely wound transformer ratio arms and highly stable standards fabricated from Invar and hermetically sealed in dry nitrogen. For calibration these standards can be intercompared.

Two- or Three- Terminal Connection - Accurate three-terminal measurements can be made even in the presence of capacitances to ground as large as 1 μ F, as might be encountered with the unknown connected by means of long cables. The bridge has the necessary internal shielding to permit one terminal of the unknown capacitor to be directly grounded, so that true two-terminal and three-terminal measurements can both be made over the whole capacitance range.

1620 PRECISION CAPACITANCE MEASUREMENT SYSTEM

Performance: See 1615-A for performance specifications.

Supplied: 1615-A Precision Capacitance Bridge.
1311-A Oscillator.

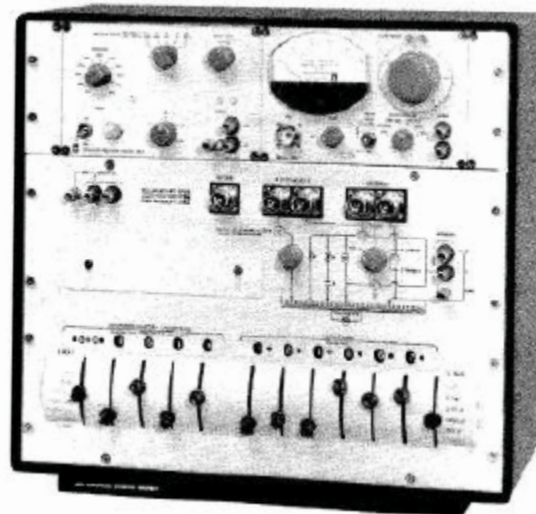

Model 1620-A Measurement System

Convenient Operation - For both capacitance and dissipation factor, the balance controls are smoothly operating, lever-type switches. The readout is digital and decimal point is automatically positioned. Each capacitance decade has a - 1 position to facilitate rapid balancing.

The 1615-A elementary diagram is also clearly delineated on the front panel of the bridge. Changes in connections and grounds are automatically indicated, as you switch the bridge terminals for different measurement conditions.

Extend Range to 11.1 F - With the 1615-P1 Range-Extension Capacitor, the 1615-A will measure to a maximum of 11.1110 F. This capacitor plugs into front-panel bridge terminals and can be adjusted for calibration to the bridge standards.

1232-A Tuned Amplifier and Null Detector.
1232-P2 Preamplifier added in 1620-AP.

1620-A Precision Capacitance Measurement System

Features

Power: 105 to 125 V and 210 to 250 V, 50 to 400 Hz, 22 W for oscillator.

Dimensions:

Bench: 48.3 cm H x 50.2 cm W x 28.0 cm D (19" x 19.75" x 11")

Weight: 27 kg (59 lb.) net, 44 kg (96 lb.) shipping

ORDERING INFORMATION

1620-A, 115 V

1620-9701

1620-AP, with 1232-P2, 115V

1620-9829

1620-A, 230 V

1620-9702

1620-AP, with 1232-P2, 230 V

1620-9830

1615-A CAPACITANCE BRIDGE

The 1615-A is an accurate, high-precision bridge for the measurement and intercomparison of standard capacitors, circuit component capacitors, or dielectric materials. It is available with oscillator and detector in the 1620-A system. Or, to take

full advantage of its wide frequency range, the bridge can be ordered separately for use with oscillator and detector especially selected for your purposes.

SPECIFICATIONS

Capacitance Measurement:

Range: 10 aF to 1.11110 μ F (10^{-17} to 10^{-6} F) in 6 ranges, direct reading, 6-figure resolution; least count 10^{-17} F (10 aF). With Range Extension Capacitor, upper limit is 11.11110 μ F.

Accuracy: At 1 kHz, $\pm(0.01\% + 0.00003 \text{ pF})$. At higher frequencies and with high capacitance, additional error is:
 $[\pm 3 \times 10^{-5}\% + 2 (C_{\mu\text{F}}) \times 10^{-3}\% \pm 3 \times 10^{-7} \text{ pF}] \times (f_{\text{kHz}})^2$

At lower frequencies and with low capacitance, accuracy may be limited by bridge sensitivity.

Comparison accuracy, external standard to unknown, 1 ppm.

Dissipation Factor:

Range: At 1 kHz, 0.000001 to 1; 4-figure resolution, least significant digit count: 0.000 001 (10^{-6}); range varies directly with frequency.

Accuracy:

$\pm[0.1\% \text{ of measured value} + 10^{-5} (1 + f_{\text{kHz}} + 5f_{\text{kHz}}C_{\mu\text{F}})]$.

Conductance:

Range: $10^{-6} \mu\text{S}$ to 100 μS , ranges +, 2 ranges-, 4 figure resolution, least count $10^{-6} \mu\text{S}$, independent of frequency, range varies with C range.

Accuracy: $\pm[1\% \text{ measured value} + 10^{-5} \mu\text{S} + 6 \times 10^2 f_{\text{kHz}} C_{\mu\text{F}} \times (1 + f_{\text{kHz}} + 5f_{\text{kHz}} C_{\mu\text{F}}) \mu\text{S}]$.

Frequency: Approximately 50 Hz to 10 kHz. Useful with reduced accuracy to 100 kHz. Below 100 Hz, resolution better than 0.01% or 0.01 pF required preamplifier or special detector.

Standards: 1000, 100, 10, 1, 0.1, 0.01, 0.001 and 0.0001 pF.

Temperature coefficient of capacitance is less than 5 ppm/C for the 1000, 100, and 10 pF standards, slightly greater for the smaller units.

Generator: Maximum safe generator voltage ($30 \times f_{\text{kHz}}$) volts, 300 V max. If generator and detector connections are interchanged, 150 to 500 V can be applied, depending on switch settings.

IET 1311-A Audio Oscillator is recommended.



1232-A Tuned Amplifier And Null Detector

A sensitive null detector like this is the key to many a fussy bridge measurement. Battery operation frees the 1232 from power-line noise and makes it ultra portable. Low-noise solid state circuitry and high gain make it very sensitive. Its tunability and choice of bandwidth enable your to reject broadband noise as well as the harmonics that might otherwise impair good measurements.

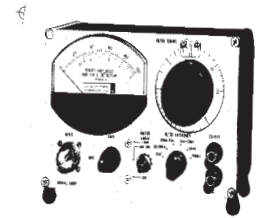

- Bridge detector at audio frequencies; with 1232-P2 Preamplifier it is equally sensitive for extremely high-impedance sources
- Audio preamplifier and general-purpose, tunable or broadband audio amplifier

- Sensitive audio wave analyzer for approximate measurements
- 20 Hz to 20 kHz, 50 and 100 kHz
- 0.1 μS sensitivity
- Bandwidth approximately 5%
- 120 dB gain

SPECIFICATIONS

Frequency:

Tunable filters: 20 Hz to 20 kHz in 3 ranges, between 2% and 6% bandwidth to 15 kHz. Second harmonic at least 34 dB down from peak, third harmonic at least 40 dB down, rejection filter on two highest ranges reduces 60 Hz level to at least 60 dB below peak response (50 Hz level is down >50 dB). Dial accuracy is $\pm 3\%$.

Fixed-Tunable Filters: 50 kHz, 2-nd harmonic is 44 dB down; 100 kHz, 2-nd harmonic is 53 dB down.

Flat Response: ± 3 dB from 20 Hz to 100 kHz.

Sensitivity: See fig. 1. Typically better than 0.1 μS over most of the frequency range.

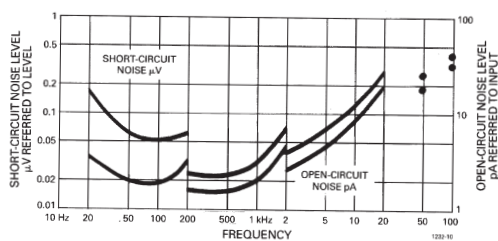
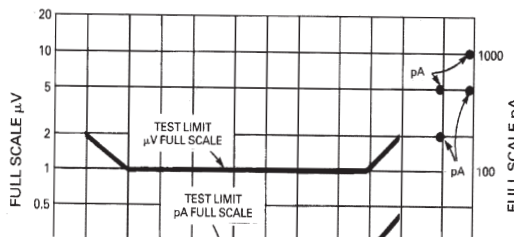

Noise Level: Referred to input: See fig. 2. Noise at 1 kHz < 2 dB at optimum source impedance of 27 k Ω . Referred to output: < 5 mV on FLAT filter-frequency position, main gain setting, and 20 dB switch position. < 50 mV in MAX SENS position.

Signal Input:

Impedance: Approximately 50 k Ω at max gain; varies inversely with gain to 1 M Ω at min gain.

Max Safe Voltage: 200 Vac or 400 Vdc.

Output:

Voltage Gain: Approximately 120 dB on the tunable ranges; 100 dB, flat range; 106 dB at 50 kHz; 100 dB at 100 kHz position.

Level: 1 V into 10 k Ω when meter indication is full scale.

Internal Impedance: 3 k Ω .

Meter Linearity: dB differences are accurate to $\pm 5\% \pm 0.1\%$ division for inputs of less than 0.3 V.

Compression: (meter switched to LOG) Reduces full-scale sensitivity by 40 dB. Does not affect bottom 20% of scale.

Attenuation: (meter switched to - 20 dB). Linear response with 20 dB less gain than MAX SENS.

Distortion: (filter switched in FLAT position): < 5 % (due to meter rectifiers).

Terminals:

Input: 874 Coaxial Connector.

Output: binding posts.

Available: 1232-P2 Preamplifier to maintain sensitivity of 1232-A at low frequencies when operating from a source impedance above 100 k Ω .

Features

Power: 12 Vdc, from 9 mercury (Eveready type E4 or equivalent) cells in series. Estimated battery life 1500 hours.

Mechanical: Convertable-bench cabinet.

Dimensions: 15.2 cm H x 20.3 cm W x 19.0 cm D (6" x 8" x 7.5").

Weight: 2.6 kg (5.75 lb) net, 3.7 kg (8 lb) shipping.

ORDERING INFORMATION

1232-A 1232-9701 Tuned Amplifier and Null Detector

1232-AP 1232-9829 Tuned Amplifier and Null Detector with preamplifier



IET LABS, INC. in the **GenRad** Tradition
534 Main Street, Westbury, NY 11590

www.ietlabs.com
TEL: (516) 334-5959 • (800) 899-8438 • FAX: (516) 334-5988

1232-P2 Preampifier

The 1232-P2 has particular application to measurements with the 1615-A Capacitance Bridge. It increases sensitivity for measurements made at frequencies well below 1000 Hz if the bridge is set to both its lowest C

and D (not G) ranges simultaneously. Low-frequency measurement of small samples of dielectric materials can be made more accurately with the addition of this preamplifier.

SPECIFICATIONS

Voltage Gain: Approximately 0.7.

Noise: (referred to input) Open-circuit equivalent, 0.1 pA. Short-circuit equivalent, 0.3 μ S (when used with Type 1232-A tuned to 100 Hz).

Impedances:

Input: > 100 m Ω in parallel with 70 pF.
Optimum Source: 3 M Ω .
Output: 10 k Ω .

Connectors: 874 on cables, input and output.

Features

Power: 12 V, 200 μ A, supplied by 1232-A.

Mechanical: Special cabinet.

Dimensions: 15.2 cm H x 1.9 cm W x 19.0 cm D
(6" x 0.75" x 7.5").

Weight: 0.43 kg (0.94 lb) net, 1.9 kg (4 lb) shipping.

ORDERING INFORMATION

1232-P2 1232-9602 Preamplifier

1620 PRECISION CAPACITANCE MEASUREMENT SYSTEM

SPECIFICATIONS

Detector: IET 1232-A Tuned Amplifier and Null Detector is recommended. For increased sensitivity needed to measure low-loss small capacitors (on lowest C and D ranges simultaneously) at frequencies below 1 kHz, use the 1232-AP Tuned Amplifier and Null Detector or 1238 Detector (with 1311-A Audio Oscillator).

Connections: Gen Input; Binding posts, ground terminal with shorting link. Detector, External Std, and Unknown; 874 connectors, Unknown, 2-Terminals; Binding posts.

Required: Oscillator and Detector.

Supplied: 874-WO Open-Circuit Termination, 874-R22A Patch Cord, 274-NL Patch Cord.

Available: Type 1615-P1 Range Extension Capacitor
Type 1615-P2 Coaxial Adaptor converts 2-terminal binding post connection of 1615-A bridge to G900 Precision Coaxial Connector for highly repeatable connections and enables measurements with adaptor to be reading by compensating for terminal capacitance.

Features

Dimensions: Bench: 32.4 cm H x 48.3 cm W x 26.7 cm D
(12.75" x 19" x 10.5")

Rack: 31.1 cm H x 48.3 cm W x 21.7 cm D
(12.25" x 19" x 8.5")

Weight: 18 kg (39 lb.) net, 27 kg (58 lb.) shipping

ORDERING INFORMATION

1615-A Capacitance Bridge
Bench Model 1615-9801
Rack Model 1615-9811

ACCESSORIES
1615-P1 Range-Extension Capacitor 1615-9601
1615-P2 Coaxial Adaptor, G900 to binding posts 1615-9602

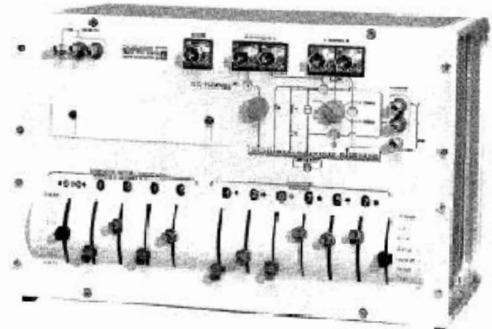

1616 Precision Capacitance Bridge

The heart of precision. The 1616 is the heart of the 1621 Capacitance-Measuring Assembly. The bridge is also available separately for use where oscillator and detector are on hand or in applications in which they must be specialized for a unique need.

The 1616 employs a transformer ratio-arm bridge with which unbalances as small as 0.1 aF (10^{-7} pF) and 100 aS ($10^{-10} \text{ } \mu\text{S}$) can be resolved. Detection of such small unbalances is aided by ratio-transformer voltage capabilities up to 160 volts at 1 kHz and by range switching that disconnects the unused internal standards in order to reduce shunt capacitance across the detector input.

For thermal stability in precision intercomparisons, eight of the twelve internal capacitance standards are mounted in an insulated compartment to reduce the effects of ambient temperature changes. Misreading the values at balance is virtually impossible due to direct-reading lever switches that control the balance for both capacitance and conductance. Panel layout is unusually neat—only the unknown capacitor and, if desired, and external standard for comparison measurements are connected to the front panel; the oscillator and detector are connected to the rear as are the BCD data-output channels.

- 10^{-7} pF to $10 \text{ } \mu\text{F}$ - 12 digital readout
- $10^{-10} \text{ } \mu\text{S}$ to $1000 \text{ } \mu\text{S}$ - 5 digital readout
- 10 Hz to 100 kHz
- up to 150-V input from oscillator
- 3-terminal measurements
- coaxial measurements



Model 1616 Precision Capacitance Bridge

SPECIFICATIONS

Capacitance measurement, 3-terminal; DECADES: 12. RANGE: 0.1 aF to $1 \text{ } \mu\text{F}$ (10^{-19} to 10^{-6} F). ACCURACY: $\pm 10 \text{ ppm}$, when most-significant decade is 1, 10, or 100 pF per step; otherwise, and at other frequencies, accuracy is $\pm(50 \text{ ppm} + (0.5 + 20 C_{\mu\text{F}})(f_{\text{kHz}} \text{ ppm} + (f_{\text{kHz}}) \text{ aF}))$.

Capacitance, 2-terminal: Same as above, except as follows. RANGE: One additional decade, to $10 \text{ } \mu\text{F}$ (10^{-19} to 10^{-5} F).

Conductance measurement, 3-terminal: DECADES: 5 (virtually extended to 11 by G multiplier). RANGE: 100 aS to $100 \text{ } \mu\text{S}$ (10^{-16} to 10^{-4} S). ACCURACY: $\pm(0.1\% + 1 \text{ step in least significant decade})$. There is a small reduction in conductance accuracy at frequencies other than 1 kHz. RESIDUAL C (across conductance standards): $\pm(<0.03 \text{ pF})$.

Conductance, 2-terminal: Same as above, except as follows: RANGE: One additional decade, to $1000 \text{ } \mu\text{S}$ (10^{-16} to 10^{-3} S).

Multipliers: FOR 3-TERM: X1, X10; FOR 2-TERM: X1, X10, X100; affect both C and G. FOR CONDUCTANCE ONLY: X1, X10⁻¹, ... X10⁻⁶ (7 positions). Effects of these multipliers are included in the specified ranges.

Frequency: 10 Hz to 100 kHz.

Standards: CAPACITANCE; Air dielectric with $\text{TC} < +20 \text{ ppm}/^\circ\text{C}$ and $\text{D} < 10 \text{ ppm}$ for 8 lowest decades; Invar[®], air dielectric with TC of $+3 \pm 1 \text{ ppm}/^\circ\text{C}$ and $\text{D} < 10 \text{ ppm}$ for 3 middle decades; mica dielectric with TC of $20 \pm 10 \text{ ppm}/^\circ\text{C}$ and $\text{D} < 200 \text{ ppm}$ for 2 highest decades. ADJUSTMENTS for all capacitance standards available through key-locked door on panel. THERMAL LAG: C standards for first 8 decades mounted in an insulated compartment with a thermal time constant of 6 h (time required for compartment interior to reach 63% of ambient change). CONDUCTANCE: Metal-film resistors in T networks with small phase angles.

Comparison: Terminals provided to connect external standard for comparison measurements; 13-position panel switch multiplies standard by $-0.1, 0, \dots, +1$.

Input: The smaller of $160 f_{\text{kHz}}$ or 350 V rms can be applied to the bridge transformer at the GENERATOR terminal without waveform distortion; 500 V rms max , depending on conductance range, when GENERATOR and DETECTOR connections are interchanged.

Interface: GR900[®] locking coaxial connector on panel to connect 2-terminal unknowns, 2 gold-plated GR900[®] locking coaxial connectors on panel to connect 3-terminal unknowns and 2 to connect external standard. DATA OUTPUT; 50-pin and 36-pin type 57 connectors on rear provide connection to 8-4-2-1 weighted BCD contacts (rated at 28 V , 1 A) on each switch for capacitance and conductance values respectively. OSCILLATOR and DETECTOR: Connect to rear BNC connectors.

Required: OSCILLATOR: GR 1316 recommended. DETECTOR: GR 1238 recommended. The 1616 Bridge is available with this oscillator and detector as the 1621 Capacitance-Measuring Assembly. Available: 1316 OSCILLATOR, 1268 DETECTOR, a broad line of capacitance and resistance standards, and coaxial cables for connection of unknowns and standards.

* Accuracy stated as fraction of measured value, for these conditions; frequency, 1 kHz, except as noted, temperature, $23^\circ \pm 1^\circ\text{C}$; humidity, $<50\% \text{ RH}$.

^t Registered trademark of the Carpenter Steel Co.
National stock numbers are listed at the back of the catalog.

Mechanical: Bench or rack model. DIMENSIONS:

Bench: $35.1 \text{ cm H} \times 50.2 \text{ cm W} \times 32.7 \text{ cm D}$ ($13.81'' \times 19.75'' \times 12.88''$)

Rack: $31.0 \text{ cm H} \times 48.3 \text{ cm W} \times 26.8 \text{ cm D}$ ($12.22'' \times 19'' \times 10.56''$).

WEIGHT: Bench, 26 kg (57 lb) net, 32 kg (69 lb) shipping; rack, 23 kg (49 lb) net, 28 kg (61 lb) shipping.

Ordering: 1616-9700 Bench Model
1616-9701 Rack Model



1621 Precision Capacitance Measurement System

The whole of precision. The 1621 represents the first major improvement in nearly a decade in ultra-precise laboratory capacitance intercomparisons and dielectric measurements. It is a completely self-contained system capable of capacitance measurements in increments as small as 0.1 aF (10^{-7} pF) and conductance measurements in increments as small as 100 aS (10^{-10} μ S; equivalent to a shunt resistance of 10^{10} M Ω). Measurements are three terminal, with 2- or 3-terminal connection, and provision is also made for the connection of an external standard for comparison measurements. Such capability and precision are usually accompanied by restricted frequency and complex operation. The 1621, however, avoids these difficulties. Little degradation of performance occurs from 10 Hz to 10 kHz and operation to 100 kHz is possible. Balances are achieved by in-line readout lever switches—easily adjusted and read correctly. All digits of capacitance and conductance, as well as pertinent multipliers, are also provided by BCD-

- 10^{-7} pF to 10 μ F
12-digital readout, 10-ppm basic accuracy
- 10^{-10} μ S to 1000 μ S
5-digital readout, 0.1% basic accuracy
- 3-terminal measurements with 2- or 3-terminal connection
- comparison measurements
- simple lever balance with in-line readout

Model 1621 Precision Capacitance Measurement System

coded contact closures, available* at rear-panel connectors for use by printers or data-processing equipment.

Three integrated units. The 1621 is an assembly of three integrated instruments: A precision ratio-arm bridge, a highly stable oscillator, and an extremely sensitive detector. Most of the bridge's internal standards are enclosed in an insulated housing to reduce the effects of ambient temperature changes; unused standards are disconnected to reduce shunt capacitance at the detector input. The oscillator provides up to 125 V or 5 A for sufficient signal to be detected even with unbalances as small as one part in 10^8 of 10 pF. The detector contains three meters to help you speed the balance: One displays the magnitude and the other two simultaneously display the in-phase and quadrature components of any unbalance.

* National stock numbers are listed on the back of the catalog.



SPECIFICATIONS

Frequency: 10 Hz to 100 kHz.

Supplied: 1616 Precision Capacitance Bridge, 1316 Oscillator, 1238 Detector, all necessary interconnection cables, and power cord.

Available: 1408 REFERENCE STANDARD CAPACITORS (10 pF and 100 pF) for calibration.

Power: 100 to 125 and 200 to 250 V, 50 to 60 Hz, 51 W.

Mechanical: Bench or rack models.

DIMENSIONS:

Bench: 61.6 cm H x 50.2 cm W x 38.1 cm D (24.25" x 19.75" x 15"),

Rack: 53.1 cm H x 48.3 cm W x 29.1 cm D (20.91" x 19" x 11.44").

WEIGHT:

Bench: 48 kg (105 lb) net, 64 kg (140 lb) shipping;

Rack: 41 kg (90 lb) net, 57 kg (125 lb) shipping.

ORDERING INFORMATION

1621 Precision Capacitance-Measurement System

1621-9701 Bench Model, 60 Hz
1621-9702 Rack Model, 60 Hz

1621-9703 Bench Model, 50 Hz
1621-9704 Rack Model, 50 Hz



IET LABS, INC. in the **GenRad** Tradition
534 Main Street, Westbury, NY 11590

www.ietlabs.com
TEL: (516) 334-5959 • (800) 899-8438 • FAX: (516) 334-5988

1238 Detector

Designed for the difficult. If you've ever had to extract a small signal from noise or to resolve a signal into its in-phase and quadrature components, you can appreciate the advantages of the 1238. With its high gain -130 dB-and meters not only for magnitude of the input signal but for the in-phase and quadrature components as well, the 1238 lends itself handily to the most exacting applications.

This high-performance detector is attractive in other respects also, including 1-G Ω input impedance for minimum loading, overload protection against signals up to 200 V. and flat or tuned frequency response (with or without line-frequency rejection) to tailor the detector to your signal no matter how "tainted" it might be.

Excellent bridge detector. In combination with a special oscillator, GR 1316, that supplies the necessary quadrature reference channels, this detector is superb for sensitive audio-frequency detection. The combination is specifically intended for use with the 1616 Precision Capacitance Bridge, enabling resolutions of one part in 10⁶ of 10 pF. Refer to the 1621 Precision Capacitance Measurement System.

The 1238 Detector consists of a high-impedance low-noise preamplifier, a tuned amplifier, a compression amplifier, and two phase-sensitive detectors. Three panel meters provide the indications: one displays the magnitude of the input signal and two others simultaneously display its in-phase and



quadrature components. The reference signals can be rotated continuously from 0 through 360° to ensure that the phase meters respond independently to the components of significance to you, for the most rapid bridge balances or signal analysis.

The effects of noise, hum, or any other input-signal contaminants are normally reduced or eliminated from your measurements by means of a tunable filter, line-rejection filter, and selectable time constants in the phase-sensitive detector circuits - all controlled from the front panel by the simple push of a button or turn of a knob.

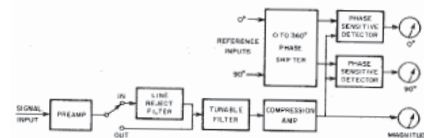

- 10 Hz to 100 kHz
- 100-nS full-scale sensitivity

- magnitude, in-phase, and quadrature meters for rapid bridge balances
- excellent bridge detector

SPECIFICATIONS

Frequency: 10 Hz to 100 kHz, flat or tuned. FLAT: ± 5 dB from 10 Hz to 100 kHz. TUNED: Set by 4 in-line readout dials with $\pm 5\%$ of reading accuracy, 2 to 4% bandwidth, and second harmonic 30 dB down from peak. LINE-REJECTION FILTER: Reduces line level by 40 dB while signal is down 6 to 10 dB at 10 Hz from line frequency; filter can be switched out.

Signal Input from bridge or other source: Applied to rear BNC connector. SENSITIVITY: Also see curve; 100 nS rms typical for full-scale deflection at most frequencies, compression can be switched in to reduce full-scale sensitivity by 20 dB. IMPEDANCE: 1 G Ω /20 pF. MAXIMUM INPUT: 200 V rms. VOLTAGE GAIN: ~ 105 dB in flat mode, ~ 130 dB in tuned mode. set by 12-position switch. SPOT NOISE VOLTAGE: $< 30 \text{ nS} \times \sqrt{\text{bandwidth}_{\text{Hz}}}$ at 1 kHz with input impedance of 70 M Ω /500 pF. MONITORED by magnitude, in-phase, and quadrature meters; phase-sensitive detectors contain time-constant variable from 0.1 to 10 s in 5 steps.

Reference Inputs from oscillator: Applied to rear BNC connectors. Two 1-V rms reference signals required, with 90° phase difference between them. PHASE SHIFTER rotates both references continuously from 0 to 360° and two verniers rotate each reference individually $\sim 10^\circ$.

Outputs: MAIN AMPLIFIER: 4 V rms (approx 2.3 V for full scale

on Magnitude meter) available at rear BNC connector. MAGNITUDE: 6 V dc for full scale deflection; PHASE DETECTORS: Up to 1 V dc each for full scale deflection (depending on Sensitivity setting); available at rear 5-pin type 126 jack.

Environment: TEMPERATURE: 0 to +55°C operating, -40 to +75°C storage. BENCH HANDLING: 4 in. or 45° (MIL-810A-VI). SHOCK: 30 G, 11 ms (MIL-T-4807A-4.5-3A).

Required: Oscillator with 0 and 90° outputs; the 1316 Oscillator is recommended.

Power: 100 to 125 and 200 to 250 V. 50 to 60 Hz. 15 W.

Mechanical: Bench or rack models.

DIMENSIONS:

Bench: 16.9 cm H x 49.7 cm W x 32.9 cm D (6.66"x19.56"x12.94")
Rack, 13.3 cm H x 48.3 cm W x 33.2 cm D (5.22"x19"x13.06").

WEIGHT: Bench: 13 kg (27 lb) net, 19 kg (40 lb) shipping, rack 10 kg (21 lb) net, 16 kg (34 lb) shipping.

ORDERING: 1238-9700 60-Hz Bench Model
1238-9701 60-Hz Rack Model
1238-9703 50-Hz Bench Model
1238-9704 50-Hz Rack Model



1316 Oscillator

Convenience and performance Set four controls and the 1316 provides any frequency from 10 Hz to 100 kHz with 1% accuracy and with little chance of an improper setting-the dials provide in-line readout, including decimal point and frequency units. Set two more controls, and the 1316 provides up to 1.6 watts of output power (125 V open circuit or 5 A short circuit), low distortion, and accurate metering.

These features alone would qualify the 1316 as an excellent general-purpose oscillator but it offers more: Output constant within $\pm 2\%$, excellent stability (only 0.005% drift over a 12-hour period), and a synchronizing feature that allows the oscillator to be locked to an external standard for even greater accuracy and stability.

Excellent bridge oscillator The 1316 is a high-performance bridge oscillator specifically intended for use with the 1238 Detector and the 1616 Precision Capacitance Bridge. The oscillator supplies 2 references (in quadrature) for the 2-phase phase-sensitive detector,

- 10 Hz to 100 kHz
- up to 125 V or 5-A output
- output level adjustable and metered

which enables you to make independent and ultra-precise balances of the conductance (real part) and capacitance (imaginary part) of capacitive devices.

The 1316 contains a Wien-bridge oscillator isolated from the load by a low-distortion transformer coupled power amplifier. The oscillator circuit includes a provision to introduce a synchronizing signal for phase locking or to extract a signal, independent of the output setting, to operate a counter or to synchronize an oscilloscope.



Model 1316 Oscillator

- in-phase and quadrature reference outputs
- in-line readout dials
- current-limited output - short circuits OK

SPECIFICATIONS

Frequency: 10 Hz to 100 kHz in 4 decade ranges. Controlled by one 11-position and one 10-position switch for the most significant digits and a continuously adjustable dial with detented zero position for the third digit; in-line readout with decimal point and frequency units.

Accuracy: $\pm 1\%$ of setting with continuously adjustable dial at zero detent position. DRIFT (typical at 1 kHz): Warmup 0.1%, short-term (10 min) 0.001%, long-term (12 h) 0.005%. RESETTABILITY: Within 0.005%.

National stock numbers are listed at the back of the catalog.

Power Output: CONTROLLED by 5-position switch and uncalibrated vernier. MONITORED by meter with $\pm 3\%$ accuracy. AVAILABLE at rear BNC connector.

Output Range	1.5 V	5 V	15 V	50 V	150 V
Open Circuit E, rms	≥ 1.25 V	≥ 4 V	≥ 12.5 V	≥ 40 V	≥ 125 V
Distortion	$< 0.2\%$ from 100 Hz to 10 kHz				
Hum	0.003% of max output				
Response	output constant within $\pm 2\%$ from 10 Hz to 100 kHz*				
Short Circuit I	5 A	1.6 A	0.5 A	0.16 A	0.05 A
Distortion	$< 0.2\%$ from 100 Hz to 10 kHz				
Impedance	0.25 Ω	2.5 Ω	25 Ω	250 Ω	2.5 k Ω
Power	1.6 W max into matched load				

* $\pm 5\%$ for outputs > 30 V rms at frequencies > 50 kHz.

Reference Outputs: Quadrature output lags in-phase output by 90° . Each available at rear BNC connectors.

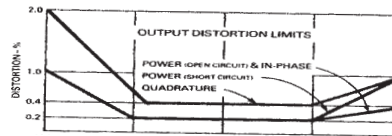

	In-Phase	Quadrature
Output, open-circuit	1.25 \pm 0.25 V rms	
Distortion, 100 Hz to 10 kHz	$< 0.2\%$	$< 0.4\%$
Response, 10 Hz to 10 kHz	$\pm 2\%$	
Response, 10 kHz to 100 kHz	$\pm 4\%$	
Minimum Load	47 k Ω	

Synchronization: INPUT: Frequency can be locked to external signal; lock range, $\pm 1\%$ V rms input up to 10 V; frequency controls function as phase adjustment. OUTPUT: 0.3 V rms behind 27 k Ω ; useful to sync oscilloscope or to drive a counter or another oscillator. Single rear BNC connector serves as both input and output terminal.

Power: 100 to 125 and 200 to 250 V, 50 to 60 Hz. 36 W.

Mechanical: Bench or rack mount.

Dimensions:

Bench: 12.7 cm H x 50.2 cm W x 33.2 cm D (5"x19.75"x13.06");
Rack: 8.8 cm H x 48.3 cm W x 29.1 cm D (3.47"x19"x11.44").

Weight: Bench: 12 kg (26 lb) net, 15 kg (32 lb) shipping,
Rack: 10 kg (21 lb) net, 12 kg (27 lb) shipping.

Ordering: 1316 Oscillator
1316-9700 Bench Model
1316-9701 Rack Model



Quality off-the-shelf or custom solutions

Since 1976, IET labs has had a long-standing commitment to **conform the instruments and standards we offer to the customer's needs** rather than to have the customer settle for what is available. We devote our customer service and applications entirely to the customer's satisfaction in the quality standards, test instruments and calibration service we provide.

- Combinations of functions; special ranges, ratings, or accuracies.
- Replacement for discontinued models from other manufacturers.
- Calibration and repair services - NIST traceable.
- Compliant with ISO-9001, ISO-10012, ANSI Z540-1-1994, and MIL-STD-45662A.
- GPIB real time process control system and applications.
- Windows hardware and software tools.
- Applications and custom engineering - readily available.
- National Stock Numbers are available for applicable models.
- All IET products are Y2K compliant.

To order or for before and after sales technical assistance:

Telephone: (516) 334-5959
(800) 899-8438
FAX: (516) 334-5988
Web site: www.ietlabs.com

Payment: Purchase orders, Visa, Mastercard, AMEX, or COD.



WARRANTY

IET Labs, Inc. warrants its products to be free from defects in material and workmanship and, when properly used, will perform in accordance with applicable IET specifications. If, within one year after original shipment, a product is found not to meet this standard, it will be repaired or, at the option of IET, replaced at no charge when returned to IET. Changes in a product not approved by IET, or application of voltages or currents greater than those allowed by the specifications, will void this warranty. IET shall not be liable for any indirect, special, or consequential damages, even if notice has been given to the possibility of such damages.

THIS WARRANTY IS IN LIEU OF ALL OTHER WARRANTIES, EXPRESSED, OR IMPLIED, INCLUDING BUT NOT LIMITED TO ANY IMPLIED WARRANTY OF MERCHANTABILITY OR FITNESS FOR ANY PARTICULAR PURPOSE.

EXTENDED WARRANTIES AND SERVICE PLANS AVAILABLE



IET LABS, INC. in the **GenRad** Tradition
534 Main Street, Westbury, NY 11590

www.ietlabs.com
TEL: (516) 334-5959 • (800) 899-8438 • FAX: (516) 334-5988

Index

A				K			
	Accessories, IEEE-488		26	KVD-500	Kelvin-Varley Voltage Divider		35
	Accessories, Probes, Micro-Ohmmeter	46-47		KVD-600	Kelvin-Varley Voltage Divider		36
LCR-500	Autoranging Handheld High Performance Digital LCR Bridge		45	KVD-700	Kelvin-Varley Voltage Divider		36
	Avoiding Measurement Problems		4	L			
B				LS-400	L-box		12
				HARS-LX	Laboratory Standard Decade Resistance Substituter	17-18	
				HARS-L	Laboratory Standard Decade Resistance Substituter		17-18
BP-511	Battery Driven ac Power Source		48	M			
C					Measurement Guidelines	4	
	Calibration Tutorial		5-7	LOM-510A	Micro-Ohmmeter		46-47
1422	Capacitance, Precision Variable		66	O			
Capacitance Measurement System:	1620-A		80-84	ohm Source Series			
	1621	85-87		P			
	Capacitance Meter		43-45		Potentiometer, Digital		35
	Capacitance Standard		31,55-69		Power Source, ac, Battery Driven		48
	Capacitance Substituter, Programmable	23		VI-700	Precision Manual or Programmable Voltage and Current Source		41
	Capacitors		9,10	1422	Precision Variable Capacitor	66-67	
1404 Series			55-56	PCS	Programmable Capacitance Substituter	23	
1408 Series			57	PLS	Programmable Inductance Substituter		23
1409 Series			58-59	PRS	Programmable Resistance Substituter		23
1412 Series			60-61	PRTD	Programmable RTD Simulator		14,23
1413 Series			62-63	R			
1417 Series			64-65	RS-200	R-box		12
	Contents		2	RCS-500	RC-box		12
CS-300	C-box		12	RTD	Resistance Substituter, Programmable	17	
	Current Source		41		RTD Simulator		30
D					RTD Simulator, Programmable		14,23
1433 Series			68-69	S			
	Decade, High Resistance	19-20		SC-900	Precision Variable Capacitor	40	
	Decade, Resistance, High Power		22	SC	Standard Capacitance Reference or Working Standards	31	
	Decade, Resistance, Programmable		14,23		Selection Guide		9-11
	Decade, RTD Simulator, Programmable	23			Simulator, RTD		14,23
	Decade Boxes, Capacitance	12,23,38,60-64		SL	Standard Inductance Reference or Working Standards	32	
	Decade Boxes, Capacitance, High Accuracy	38,60-64			Software, IEEE-488		24-26
	Decade Boxes, Inductance	12,23,53		Sound-Level:	Sound-Level Calibrator 1562-A Series	71	
	Decade Boxes, R-C	12,23			Sound-Level Meter 1565-B Series	70	
	Decade Boxes, Resistance	12,14-23,68			Standard Capacitance		31,55-67
	Decade Capacitance, Programmable	23			Standard Inductance		51-54
	Decade Substituters	12-13		SRX	Standard Resistance		28
IMF-600A	Digital Manual/Autoranging Impedance Meter	43-44			Standard Resistance		28
DP-500	Digital Potentiometer Kelvin-Varley Voltage Divider	35		SRC	Standard Resistance, High Accuracy		28
E					Standard Resistance, High Accuracy		19-20
	Electronically Controlled Resistance Box	14		Stroboscopes: 1531-AB and 1538-A		72-73	
G					1539-A Series (Light Source)		74-75
	Glossary		8		1542-B Series (Strobotac)	76-77	
H					1546 Series (Digital)		78-79
HATS-L	High Accuracy Transfer Standards Low Resistance		33		Substituter, Capacitance, High Accuracy	38-39	
HATS-Y	High Accuracy Transfer Standards High Resistance		34		Substituter, High Resistance		19-20
HACS-Z	High Accuracy Capacitance Substituter	38-39			Substituter, Resistance, High Power		22
HACS	High Accuracy Capacitance Substituter 2 or 3 Terminal Connections	37			Substituters, Capacitance	12,23,38,60-63	
HARS-X	High Accuracy Decade Resistance Substituter	15-16			Substituters, Inductance		12,23,53-54
LOM-510A	High Accuracy Micro-Ohmmeter		46-47		Substituters, R-C		12,23
SRL	High Accuracy Standard Resistance		27		Substituters, Resistance		12,23,68-69
SRR	High Accuracy Standard Resistance		27	T			
SRX, SRA	High Accuracy Standard Resistance		28		Technical Applications		4-8
HATS-LR	High Accuracy Transfer Standards		33		Transfer Standards		33-34
HATS-Y	High Accuracy Transfer Standards		34		Transfer Standards, Applications		7
HPRS	High Power Decade Resistance Substituter		22	V			
HRRS	High Resistance Decade Substituter	19-21			Voltage Divider		35-36
VRS-100	High Resistance Standards	29			Voltage Reference		35-36
HSVR	High Stability Voltage Reference		42		Voltage Source		41-42
CBL-488	IEEE-488 cables		26	W			
HI-488	IEEE-488 Interface Hardware		24-26		Warranty		88
SI-488	IEEE-488 Interface Software	24-26			Windows Tools and Measurement		24-26
	Impedance Meter		43-45				
	Inductance Standard		51-54				
Inductors:	1482 Series	51-52					
	1491 Series	53-54					
	Interface Hardware, IEEE-488		24				
	Interface Software, IEEE-488		24				

